

SUTTON CANOPY BED











WARNING : ADULT ASSEMBLY ONLY OWING TO THE PRESENCE OF SMALL PARTS, SHARP POINTS AND EDGES

Customer Service- If you are missing parts or have any questions about this product, please contact us at : 1-800-762-1751

PART LIST

- A [1] HEADBOARD PANEL
- B [4] CANOPY POSTS
- C [1] FOOTBOARD PANEL
- D [2] SIDE RAILS
- E [1] SLAT ROLL
- F [4] CONNECTION BLOCK
- G [4] CANOPY RAILS

HARDWARE LIST

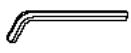
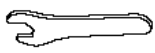
NO.		Description	Q'TY
1		Long bolt Φ 1/4"x 2-1/4"	4 pcs
2		Flat washer Φ 1/4"	4 pcs
3		Lock washer Φ 1/4"	4 pcs
4		Hex Nut Φ 5/16"	8 Pcs
5		Wood Screw Φ 8 x 1-1/4"	4 Pcs
6		Threaded rod Φ 5/16" x 3-1/4"	8 Pcs
7		Curved slotted washer	8 Pcs
8		Connecting bolt Φ 1/4"	4 Pcs
9		Camlock wheel	4 Pcs
10		Wood plug Φ 12 x 60mm	8 Pcs
11		Allen key 4mm	1 Pc
12		wrench 12mm	1 Pc

ASSEMBLY INSTRUCTION

Note: Two adults are recommended to assemble this bed.

1. Let the Headboard panel (A) lay flat on a smooth surface like packing foam. Secure the threaded rod (6) to the Canopy posts (B) and place the rod into the Headboard panel (A) at the bore holes' position, insert Curved slotted washer (7), hex nuts (4) and tighten hex nuts using wrench (12). Repeat the procedure with the Footboard (C) and the remaining canopy posts (B).
2. The side rails (D) are not handed parts so either rail will work on the right or left side. While holding the Headboard panel (A) up attached to Canopy posts (B), place the hooks in the rail into the slots in the Canopy posters (B). Using a thick magazine or book to protect the side rail seat the hook-rail with a mallet or hammer until tight. Repeat the procedure with the other rail (C). The Headboard (A) will now stand on its own with the rails supporting it. (See drawing on page 3). It might be a good idea to place something under each rail (D) to elevate them so they are level, making it easier to place the footboard (C) onto the rails (D), but is not necessary. Insert the rail hooks into the slots in the footboard (B) and seat using the method described above.

Our hook-rail construction allows you to adjust the height of the bed for 2 settings. The higher setting is for use with a trundle and for use without a box spring. The lower setting is for use with a box spring. To insure the correct setting please measure the following distances:

Higher setting- distance from the floor to the bottom of the hook-rail measures 11.5".

Lower setting- distance from the floor to the bottom of the hook-rail measures 7.5".

3. Lay the slat roll (F) in between the side rails (E) and use wood screws (2) to fasten 2 end slats to the side rails with a screwdriver.

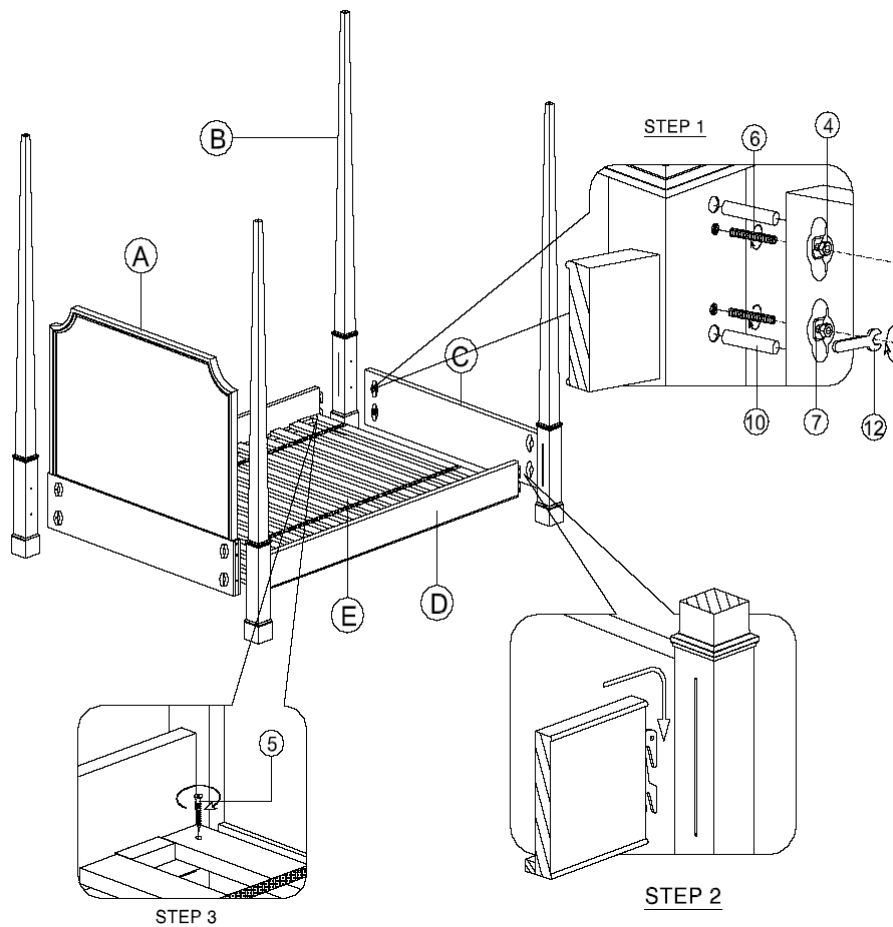

4. Insert connecting bolts (8) to the Connection block (F). Then secure the Canopy rails (G) to the Connection block (F). Place cam lock wheel (9) into the holes inside of the canopy rails by aligning the arrow sign of the cam lock wheel to the connecting bolt and twist to tighten by counter clockwise direction using Phillip head screwdriver (not provided). Repeat the same procedure to the other 3 connection points of canopy set.
5. This final procedure should be done by 2 people working together to carefully lift assembled canopy and place on top of bed posts. Insert the Flat washer (2), Lock washer (3), Long bolt (1) into the holes of Connection block (F). Tighten with allen key (11). (See drawing below).

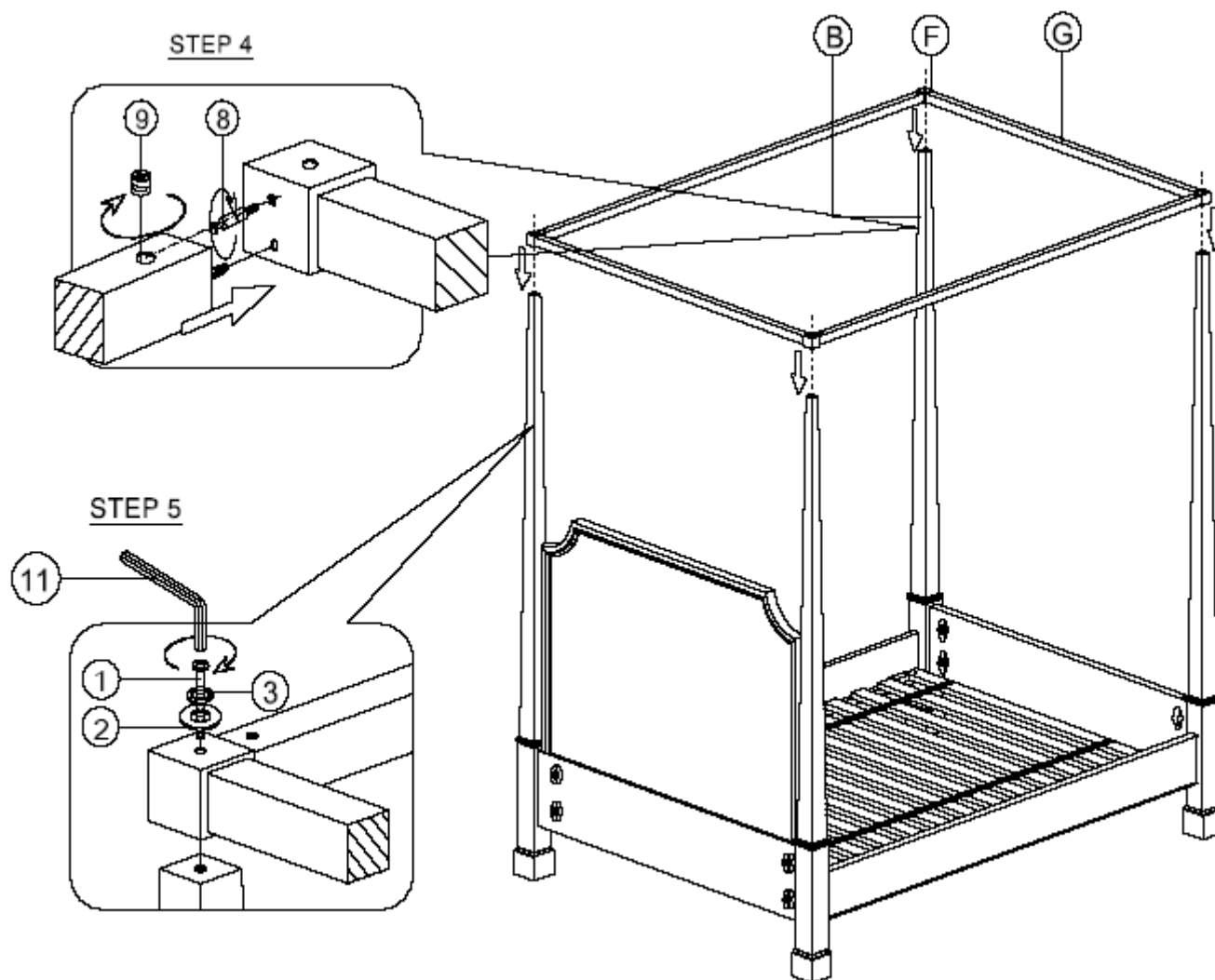

Thank you for your purchase
www.rhbabyandchild.com