

# baby & child RESTORATION HARDWARE

**All Restoration Hardware cribs are designed to meet the highest safety standards and comply with all U.S. and Canadian cribs and cradles regulations.**

Assembly Instructions For Crib  
**baby&child**  
RESTORATION HARDWARE

Restoration Hardware Baby & Child  
2900 North Macarthur Drive  
Tracy, California 95376  
restorationhardware.com  
Made in Vietnam

Model No: 5743-A612  
"Hampton Collection"

Distributed in the U.S.A. by:  
Restoration Hardware Baby & Child  
2900 North Macarthur Drive  
Tracy, California 95376  
restorationhardware.com

Distributed in Canada by:  
Restoration Hardware Canada, Inc.  
1500-1055 West Georgia Street,  
Vancouver, British Columbia V6E 4N7

**▲ WARNING:** Read all instructions before assembling this product. **KEEP INSTRUCTIONS FOR FUTURE USE.**



## CUSTOMER SERVICE

If you are missing parts or have any questions about this product, contact us first. You can also order parts by writing to the address above. Include the product model number, color, and a brief description of the part.  
Call 1-800-762-1751

## CARE AND CLEANING

**DO NOT** scratch or chip the finish. **DO NOT** use abrasive chemicals for cleaning. Clean with mild soap on a soft rag. Rinse and dry thoroughly. If the crib is to be stored, store in a cool dry place and carefully package all original hardware to protect from loss.

## TOOLS AND INSTALLATION

Tools Necessary: Allen Key (included).  
Flathead Screwdriver (not included).  
Phillips Screwdriver (not included).

Note: It may be easier to assemble product with two people.

**NOTE:** When inserting bolts, turn clockwise until tight. Then loosen 1/2-3/4 of a turn. After crib is completely assembled, return to each bolt and tighten. Use wax or soap on all bolts to facilitate assembly.

## IMPORTANT SAFETY INFORMATION FOR CRIBS

**▲ WARNING:** Infants can suffocate on soft bedding.  
Never add a pillow or comforter. Never place additional padding under an infant.

**▲ WARNING:** Failure to follow these warnings and the assembly instructions could result in serious injury or death.

▪To reduce the risk of **SIDS**, pediatricians recommend healthy infants be placed on their backs to sleep, unless otherwise advised by your physician.

### ***Strangulation Hazard:***

- Strings can cause strangulation! **DO NOT** place items with a string around a child's neck, such as hood strings or pacifier cords. **DO NOT** suspend strings over a crib or attach strings to toys.
- To help prevent strangulation tighten all fasteners. A child can trap parts of the body or clothing on loose fasteners.
- DO NOT** place crib near window where cords from blinds or drapes may strangle a child.

### ***Fall Hazard:***

- When child is able to pull to a standing position, set mattress to lowest position and remove bumper pads, large toys and other objects that could serve as steps for climbing out.
- When child is able to climb out or reaches the height of 35 in. (90 cm), the crib shall no longer be used, and the child should be placed in a youth or regular bed.
- Check this product for damaged hardware, loose joints, missing parts or sharp edges before and after assembly and frequently during use. **DO NOT** use crib if any parts are missing, damaged or broken. Contact Bassett Furniture Industries, Inc. for replacement parts and instructional literature if needed. **DO NOT** substitute parts.
- DO NOT** use a water mattress with this crib.
- If refinishing, use a non-toxic finish specified for children's products.
- Follow warnings on all products in a crib.
- Never use plastic shipping bags or other plastic film as mattress covers because they can cause suffocation.
- Infants can suffocate in gaps between crib sides and a mattress that is too small.

## IMPORTANT SAFETY INFORMATION FOR CRIBS

**CAUTION: ANY MATTRESS USED IN THIS CRIB MUST BE AT LEAST 27-1/4 INCHES BY 51-5/8 INCHES WITH A THICKNESS NOT EXCEEDING 6 INCHES.**

### **WARNING**

- Do not use this crib if the enclosed or attached instructions cannot be strictly adhered to. Do not use this crib if the child is able to climb out unaided or is taller than 90 cm. Do not place cords, straps or similar items that could become wound around the child's neck in or near this crib. Ensure that the sides are properly latched or locked in place when the crib is occupied. The mattress used with this crib should not be more than 15 cm thick and should be of such length and width that the gap between the mattress and the sides of the crib is not more than 3 cm when the mattress is pushed into the corner of the crib.
- Parents should inspect the crib regularly -- before putting the child in the crib each day -- and confirm that every component of the crib is properly and securely in place.

**▲WARNING:  
ENTRAPMENT/STRANGULATION  
HAZARD**

**Infants have died in toddler beds from entrapment and strangulation. Failure to follow these warnings and the assembly instructions could result in serious injury or death.**

**NEVER use bed with children under 15 months.**

**NEVER place bed near windows where cords from blinds or drapes may strangle a child.**

- The mattress intended for use on the bed shall be a full-size crib mattress having minimum dimensions of 51-5/8 in. (1310 mm) in length, 27-1/4 in. (690 mm) in width and 4 in. (100 mm) in thickness, not exceeding 6 in. (152 mm) in thickness.
- If guardrails are used as the mattress containment means, guardrail(s) provided must be used to avoid the formation of a gap between the mattress and the bed that could cause an entrapment.
- DO NOT** place bed near windows where cords from blinds or drapes may strangle a child.
- DO NOT** place items with a string, cord, or ribbon around a child's neck, such as hood strings or pacifier cords.
- DO NOT** suspend strings over a toddler bed for any reason.
- A child using the toddler or day bed shall be at least 15 months of age and shall not weigh more than 50 lbs. (22.7 kgs.).

# Item Identification

For ease of identification, all parts are labeled to correspond to the Step number in which the part is used.

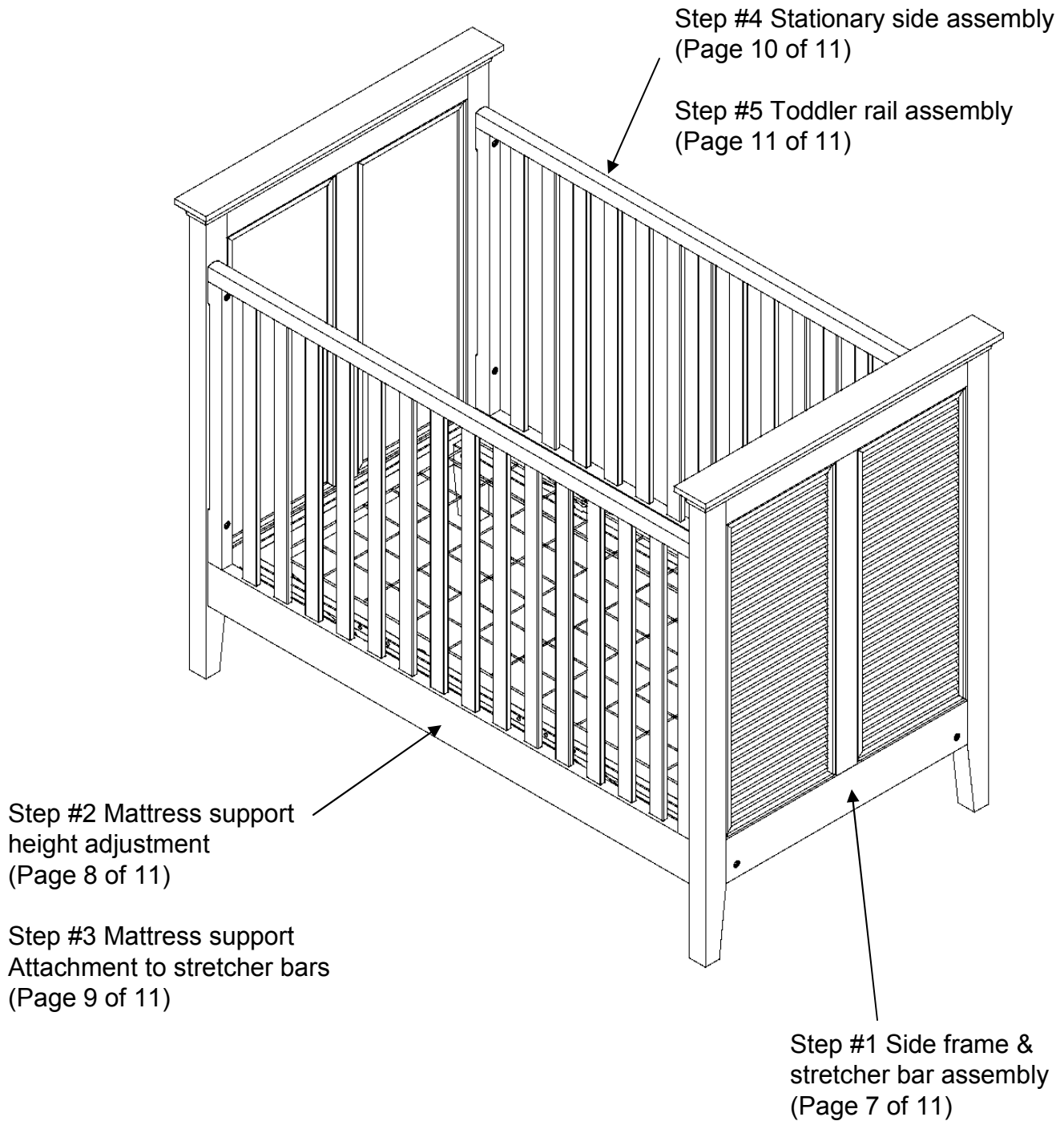

# STEP #1

## SIDE FRAME & STRETCHER BAR ASSEMBLY

Side Frame (x 2)  
 Stretcher Bar (x 2)

### Hardware needed for Step #1:

- (AA) K.D. Barrel Nuts (x 4 pieces)
- (BB) 3-1/8 in. Bolts (x 4 pieces)
- (CC) Dowel Pin (x 4 pieces)
- (DD) Allen Wrench (1 piece)
- (HH) 3/8 in. lock washer (x 4 pieces)

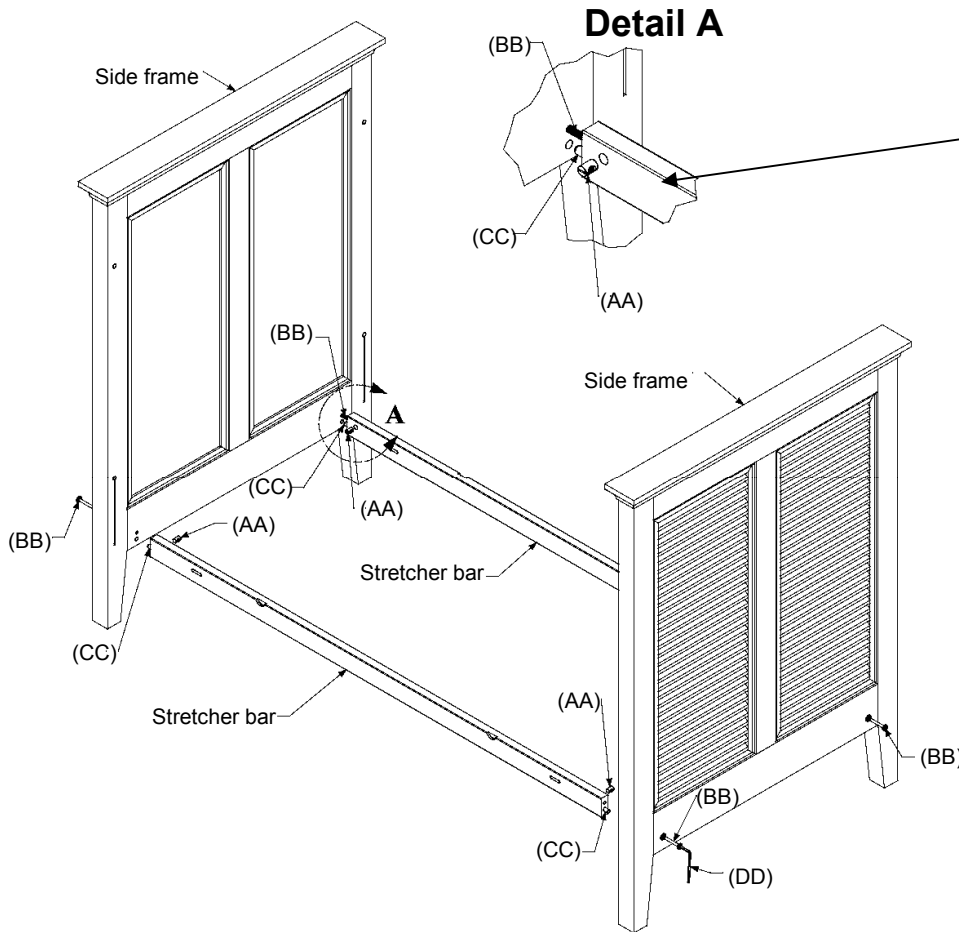

Insert barrel nuts into holes in stretcher bar

Align threaded hole in barrel nut with bolt (BB)

Note: Slot on barrel nut faces outward

Note: Do not fully tighten at this time.

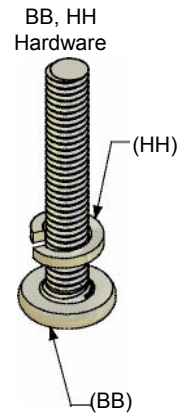

### Hardware Step # 1

(AA) K.D. Barrel nuts (x 4 pieces)

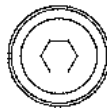
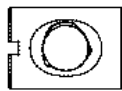

(BB) 3-1-8 in. bolts (x 4 pieces)

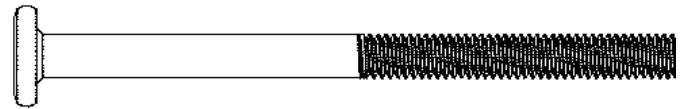

(CC) Dowel pin (x 4 pieces)

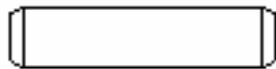

(DD) Allen Wrench (1 piece)

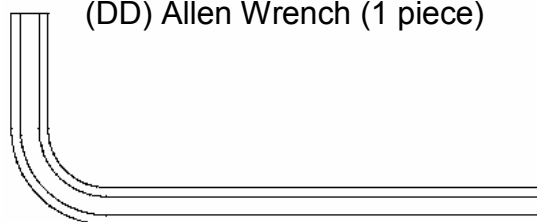

(HH) 3/8 Lock washer (x 4 pieces)



# STEP #2

## MATTRESS SUPPORT HEIGHT ADJUSTMENT

Mattress support (x 1)

Note: Do not fully  
tighten at this time.

### Hardware needed for Step #2:

- (DD) Allen Wrench (1 piece)
- (EE) Mattress nut (x 4 pieces)
- (FF) 1-3/8 in. Mattress bolt (x 4 pieces)
- (GG) Mattress washer (x 4 pieces)
- (HH) 3/8 in. lock washer (x 4 pieces)
- (OO) Multi Wrench (1 piece)

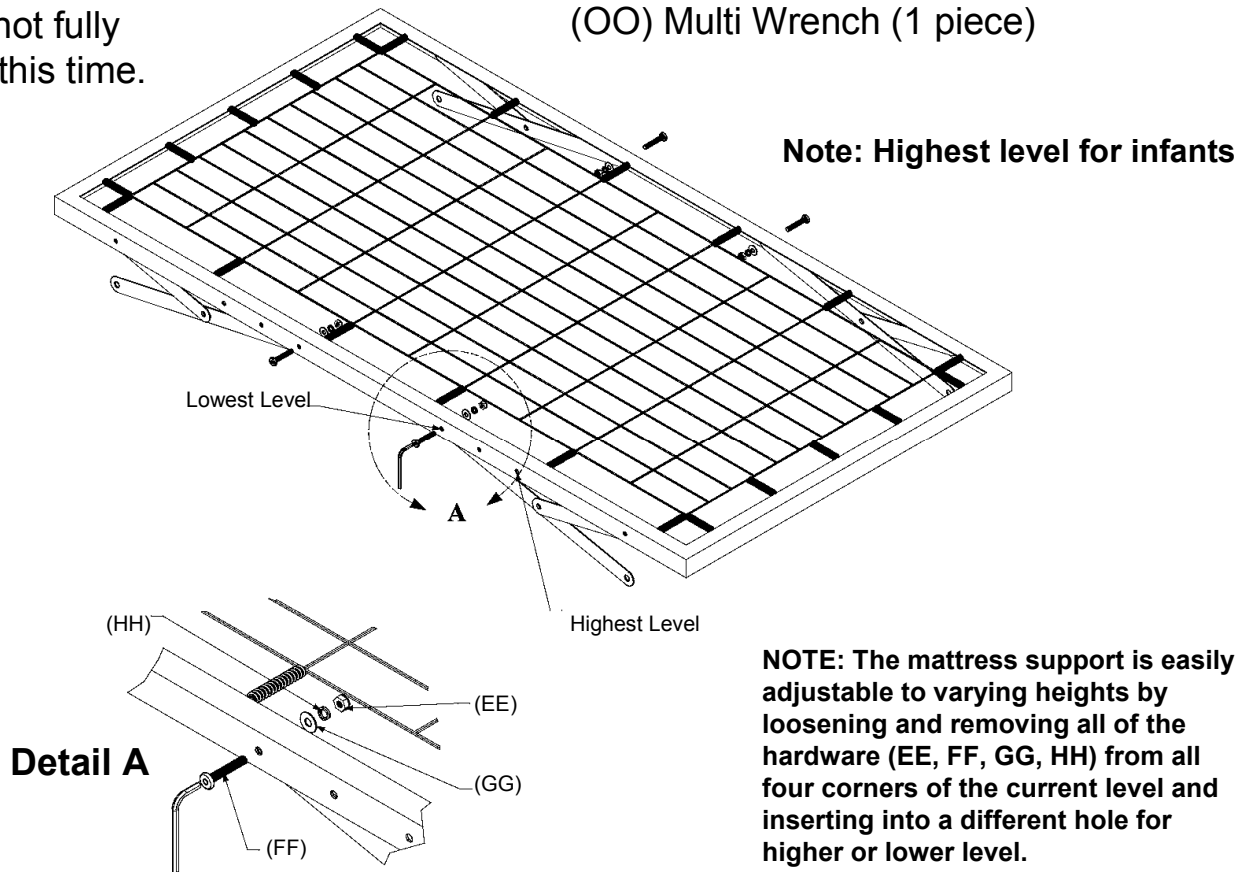

### Hardware Step # 2

(EE) Mattress Nut (x 4 pieces)



(FF) 1-3/8 in. Mattress Bolt (x 4 pieces)



(GG) Mattress Washer (x 4 pieces)

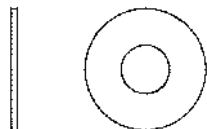

(HH) 3/8 Lock washer (x 4 pieces)

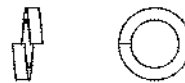

(OO) Multi Wrench (1 piece)

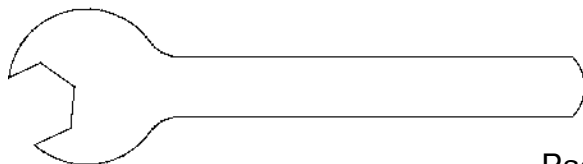

(DD) Allen Wrench (1 piece)

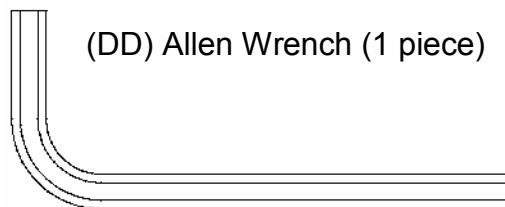



# STEP #3

## MATTRESS SUPPORT ATTACHMENT TO STRETCHER BARS

Mattress support (x 1)

Note: Do not fully tighten at this time.

### Hardware needed for Step #3:

- (DD) Allen Wrench (1 piece)
- (EE) Mattress nut (x 4 pieces)
- (FF) 1-3/8 in. Mattress bolt (x 4 pieces)
- (GG) Mattress washer (x 4 pieces)
- (HH) 3/8 in. lock washer (x 4 pieces)
- (OO) Multi Wrench (1 piece)

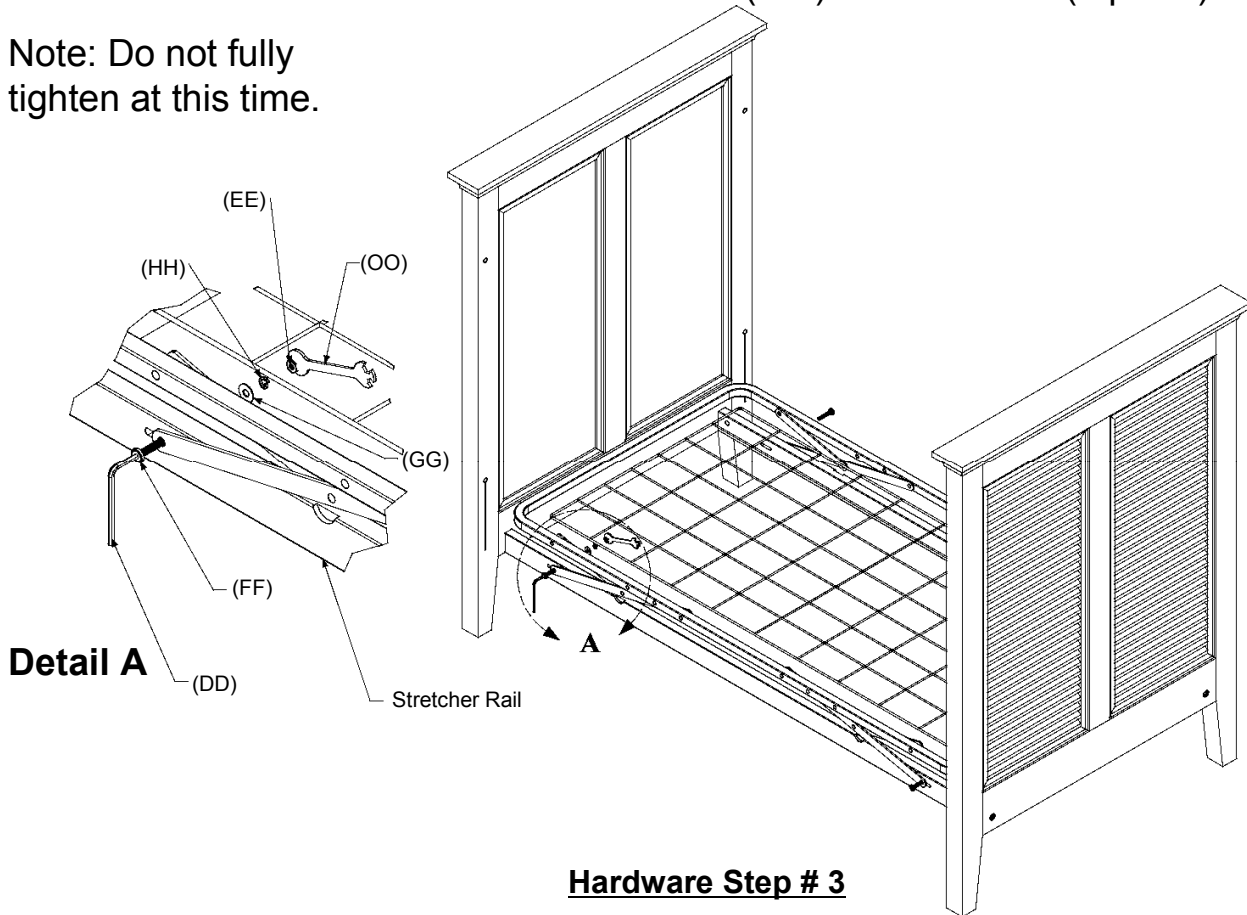

### Hardware Step # 3

(EE) Mattress Nut (x 4 pieces)



(FF) 1-3/8 in. Mattress Bolt (x 4 pieces)

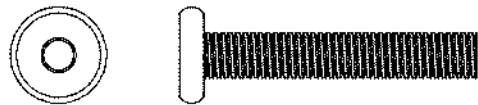

(GG) Mattress Washer (x 4 pieces)

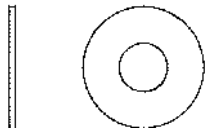

(HH) 3/8 Lock washer (x 4 pieces)

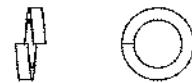

(OO) Multi Wrench (1 piece)

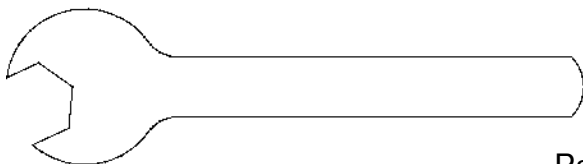

(DD) Allen Wrench (1 piece)

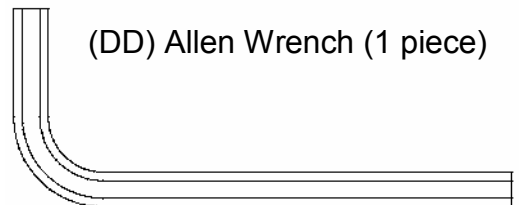

# STEP #4

## STATIONARY SIDE ASSEMBLY

Stationary Side (x 2)

### Hardware needed for Step #4:

(DD) Allen Wrench (1 piece)

(HH) 3/8 in. lock washer (x 8 pieces)

(II) 2-1/4 in. Bolt (x 8 pieces)

**▲WARNING:** After crib is completely assembled, return to each bolt and tighten to snug fit. **DO NOT** over tighten.

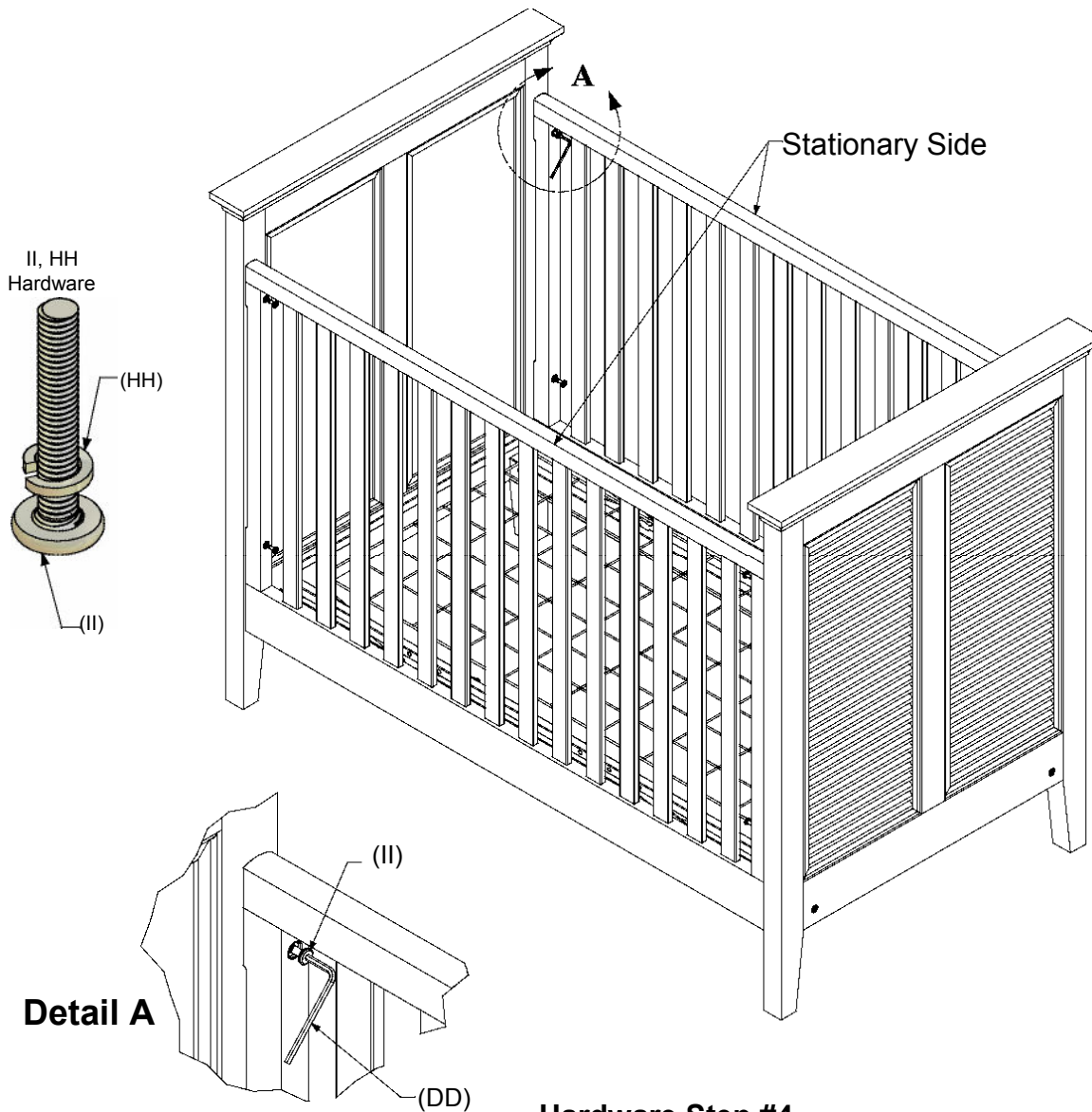

### Hardware Step #4

(II) 2-1/4 inch bolt (x 8 pieces)



(HH) 3/8 Lock washer (x 8 pieces)

(DD) Allen Wrench (1 piece)

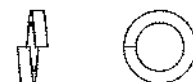
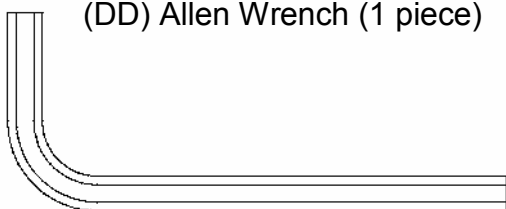

# STEP #5

## TODDLER RAIL ASSEMBLY

Toddler Rail (x 2)

### Hardware needed for Step #5:

(DD) Allen Wrench (1 piece)

(HH) 3/8 in. lock washer (x 4 pieces)

(JJ) 1/2 in. Bolt (x 4 pieces)

If mattress support is not in the lowest position, unscrew mattress support bolts and move it to the lowest position.

#### Detail A

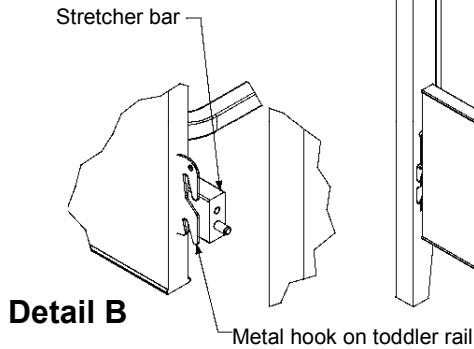
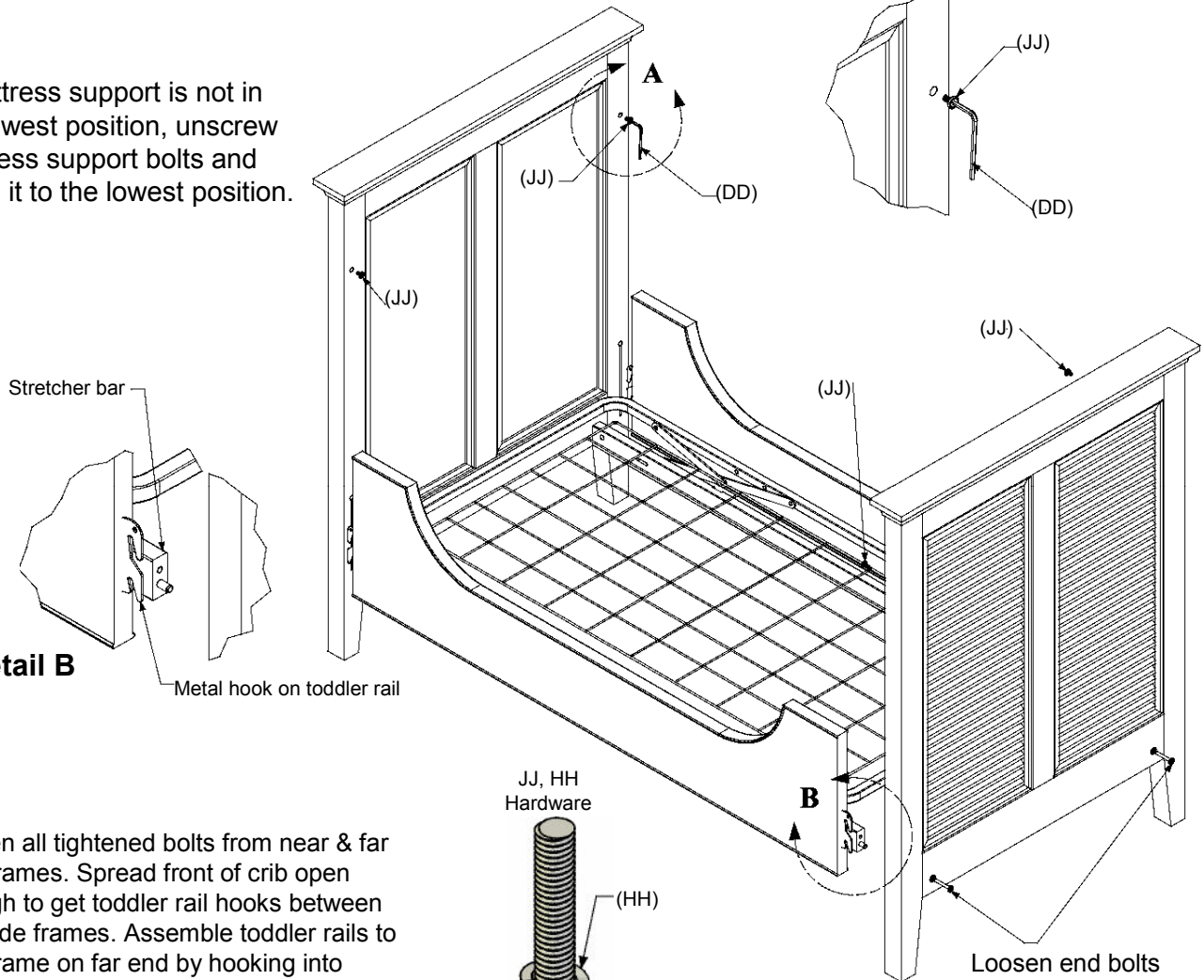
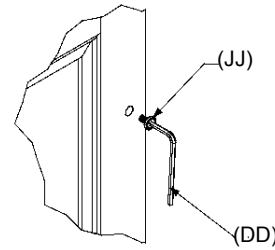

Loosen all tightened bolts from near & far side frames. Spread front of crib open enough to get toddler rail hooks between crib side frames. Assemble toddler rails to side frame on far end by hooking into provided slots while aligning stretcher bar. Assemble toddler rails to side frame on near end by hooking into provided slots while aligning stretcher bar. Retighten all bolts to snug fit.

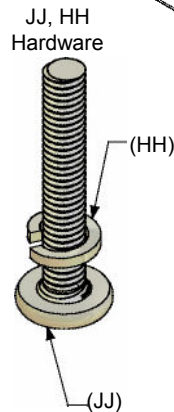

### Hardware Step # 5

(JJ) 1/2 inch plug bolt (x 4 pieces)

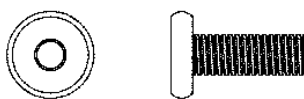

(DD) Allen Wrench (1 piece)



(HH) 3/8 Lock washer (x 4 pieces)

