

baby&child

RESTORATION HARDWARE

LAYNE FULL BED



WARNING: ADULT ASSEMBLY ONLY OWING TO THE PRESENCE OF SMALL PARTS, SHARP POINTS AND EDGES

Customer Service - If you are missing parts or have any questions about this product , please contact us at : 1-800-762-1751



PART LIST

- A [1] HEADBOARD
- B [2] SIDE RAILS
- C [1] FOOTBOARD
- D [1] SLAT ROLL

TOOLS NEEDED

- Phillips head screwdriver (not included)

HARDWARE LIST

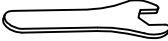
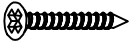
1	5/16" x 3" Threaded rod		8pcs
2	5/16" Curved slotted washer		8pcs
3	5/16" x 12mm Nut		8pcs
4	12mm Wrench		1pc
5	8 x 30mm Wood Screw		4pcs

ASSEMBLY INSTRUCTIONS :

Note: Bed can be assembled by one person rather easily, but if two people are available it is a bit easier and the operation will require less preparation. The instructions are written assuming one person is assembling the bed.

1. Place the Headboard (A) upright in the position you wish the bed to be in when fully assembled. The Headboard bed fast hardware should be facing the inside, toward the mattress.
2. Secure the Threaded Rod (1) to the Headboard (A). Raise the Side Rail (B) up and place the rod into the Side Rail (B) at the bore holes' position. Insert Curved Slotted Washer (2) and tighten Hex Nut (3) using Wrench (4) (as shown in Diagram 1). Repeat the procedure with the other Side Rail (B) and Footboard (C).

2. Lay the Slat Roll (D) in between the Side Rails (B) and use Wood Screws (5) to fasten 2 end slats to the side rails with a screwdriver (as shown in Diagram 2).

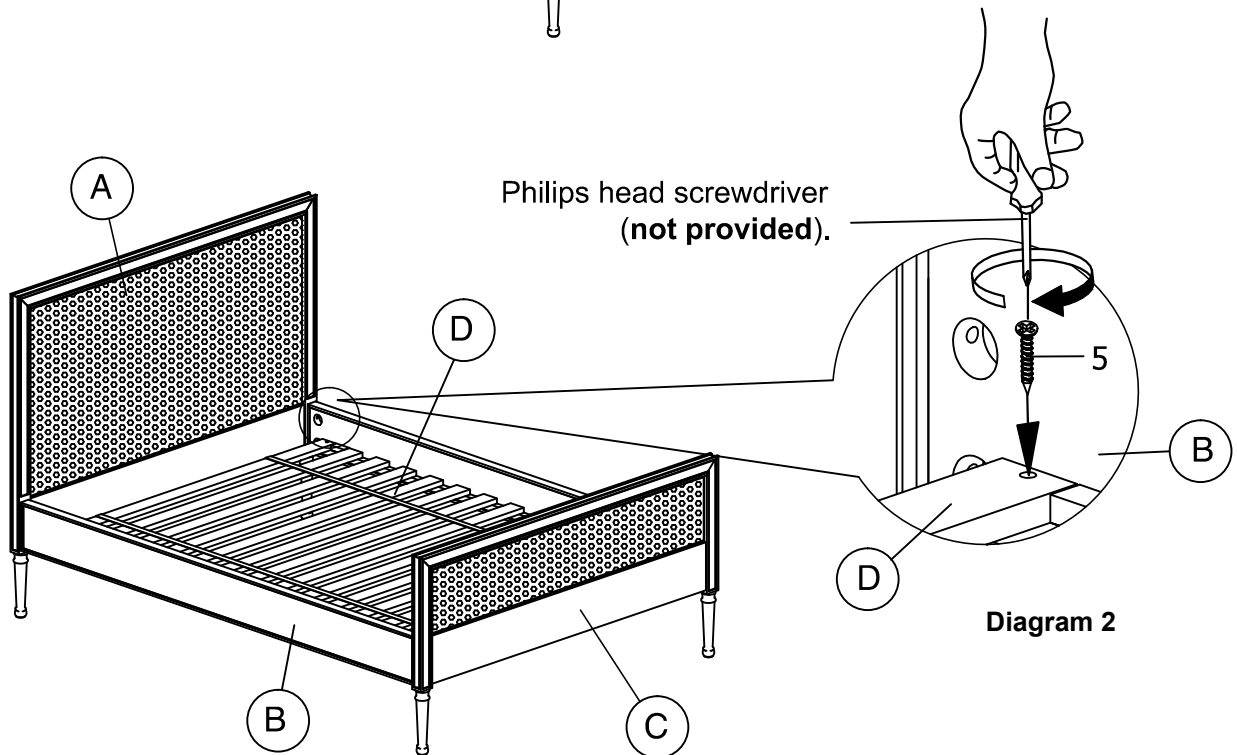
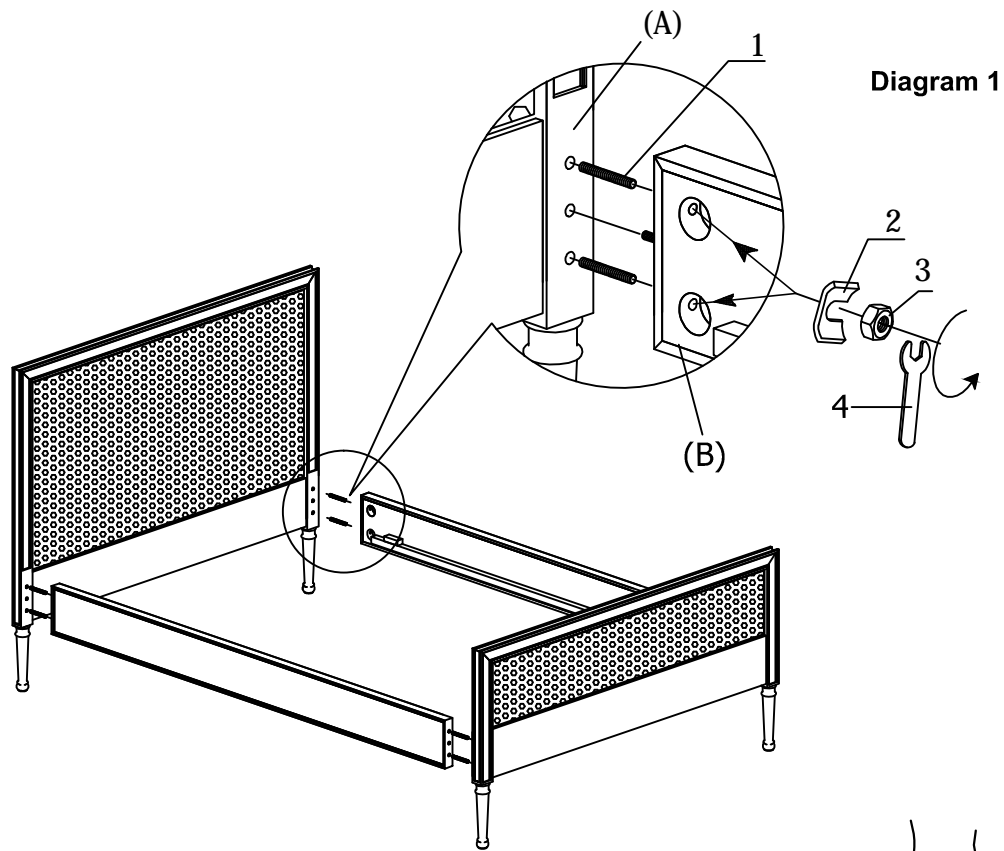

Thank you for your purchase
www.rhbabyandchild.com