

PEDIMENT BOOKCASE

⚠ WARNING: ADULT ASSEMBLY ONLY OWING TO THE PRESENCE OF SMALL PARTS, SHARP POINTS AND EDGES

Customer Service- If you are missing parts or have any questions about this product, please contact us at : 1-800-762-1751

CARE INSTRUCTIONS:

- Dust often using a clean, soft, dry lint-free cloth.
- Blot spills immediately, and wipe with a clean, damp, cloth.
- We do not recommend the use of chemical cleansers, abrasives, or furniture polish on our lacquered finish.

FURNITURE TIPPING RESTRAINT

Young children may be injured by tipping furniture and the use of a tipping restraint is highly recommended. When properly installed, this restraint could provide protection against the unexpected tipping of furniture due to small tremors, bumps or climbing. We recommend mounting this restraint to a wall stud.

WARNING: This product is only a deterrent. It is not a substitute for proper adult supervision.

TOOLS NEEDED

- Phillips screw driver (Not included)

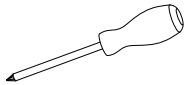

HARDWARE LIST

- (2) Plastic brackets



- (2) Phillip screws M4x5/8"



- (2) Phillip screws M4x1-1/2"

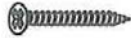

- (1) Restraint strap



ASSEMBLY INSTRUCTIONS

1. Attach one of the mounting brackets near the top back edge of the furniture piece by inserting the shorter screw.
2. Determine the final position of the furniture piece. Mark location on the wall approximately 2" below the bracket mounted to the back of the furniture
3. Drill a starter hole into the wall stud. Attach the second bracket by inserting the longer screw through the bracket and into the wall.
4. Place the furniture so the bracket on the back edge is in line with the bracket on the wall.
5. Lace one end of the nylon restraint strap down through each bracket. Bring both ends together and slide the beaded end until it snap locks into the keyhole slot.
6. To double lock, return the beaded end back through the keyholes as shown.
7. Check to make sure the strap is securely laced and locked to the brackets.
8. Wooden shelf can be adjusted, place the shelf to your desired position. Letting the supporting rail underneath of the shelf sits on the saw-tooth rail inside of the bookcase.

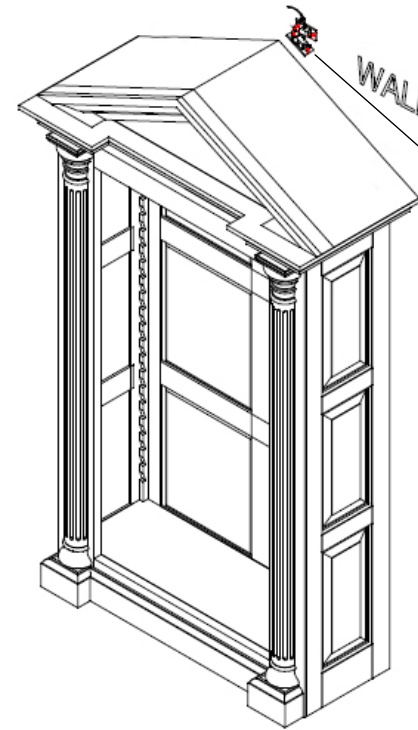

The tip kit is installed to the back of the bookcase

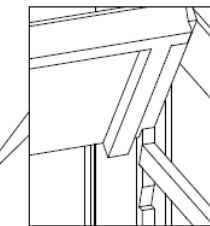
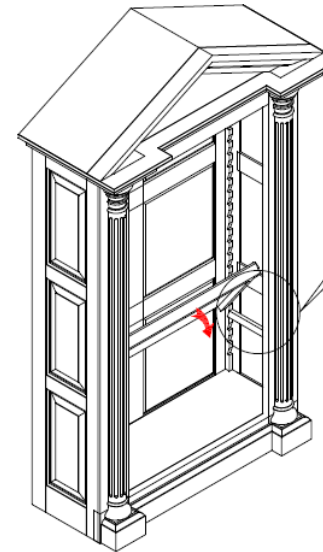
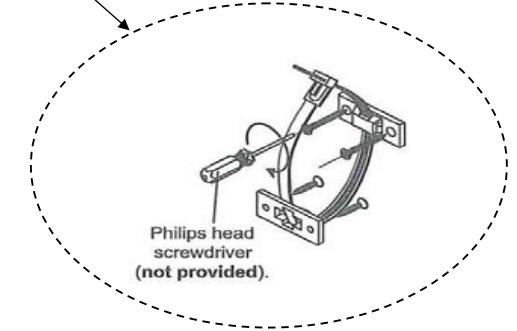

Wooden shelf can be adjusted

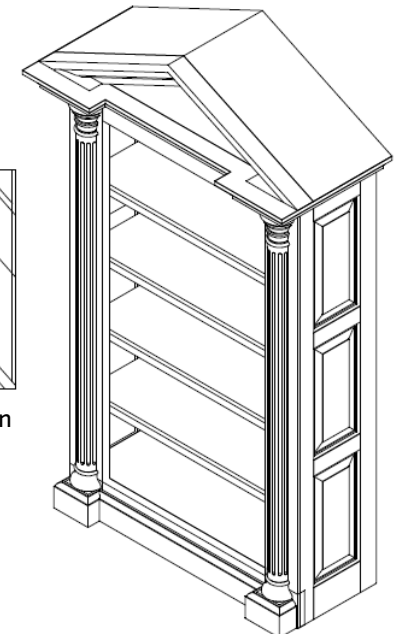

Thank you for your purchase.

www.rhbabyandchild.com