

KENWOOD UNIVERSAL GUARD RAIL



WARNING: ADULT ASSEMBLY ONLY OWING TO THE PRESENCE OF SMALL PARTS, SHARP POINTS AND EDGES

Customer Service- If you are missing parts or have any questions about this product, please contact us at : 1-800-762-1751

PARTS LIST





A [1] KENWOOD BUNK BED OR KENWOOD BED

B [1] KENWOOD UNIVERSAL GUARD RAIL

TOOLS NEEDED

- Phillips Head Screwdriver (not included)

HARDWARE INCLUDED:

NO	DESCRIPTION		Q'TY
C	Metal Bracket		2 pcs
D	L Bracket		1 pc
E	Oval Metal Plate		4 pcs
F	Metal Bracket Screw #8x3/4"		8 pcs
G	L Bracket&Oval Metal Plate Screw #3x5/8"		6 pcs

ASSEMBLY INSTRUCTIONS:

Note: Kenwood Universal Guard Rail can be assembled by one person rather easily, but if two people are available it is a bit easier and the operation will require less preparation. The instructions are written assuming one person is assembling the Kenwood Universal Guard Rail.

Step 1. Install Guard Rail (B) as indicated below and Section "A". The Guard Rail can be installed in any location of the lower side rail of the Kenwood Bunk or either siderail of the Kenwood Bed (A) that you desire. Attach Guard Rail to be in position and fasten metal Bracket(C) short end two holes with 8x3/4" screws(F) into pre-drill holes in the Guard Rail (B) first, and then fasten the metal Bracket long end two holes with 8x3/4" screws in the slat bearers on the side rails (Refer to Section "A"). The Metal Bracket on the Guard Rails fit into slots in the slat bearers on the side rails(Refer to Section "A") Secure the other end of metal bracket with 8x3/4" screws(F) that are provided.

Step 2. Attach the L brackets (D) onto the inner ends of the Guard Rail (B) to posts of the Lower Bunk or Kenwood Bed (A) by using the #3x5/8" screws (G) that are supplied with the Guard Rail and the screwdriver (Refer to Section "A").

Step 3. Install the Oval Metal Plate (E) on the bottom of Guard Rail in two locations and use Oval Metal Plate screws #3x5/8" screws (G) to secure Guard Rail and side rail together (Refer to Section "B").

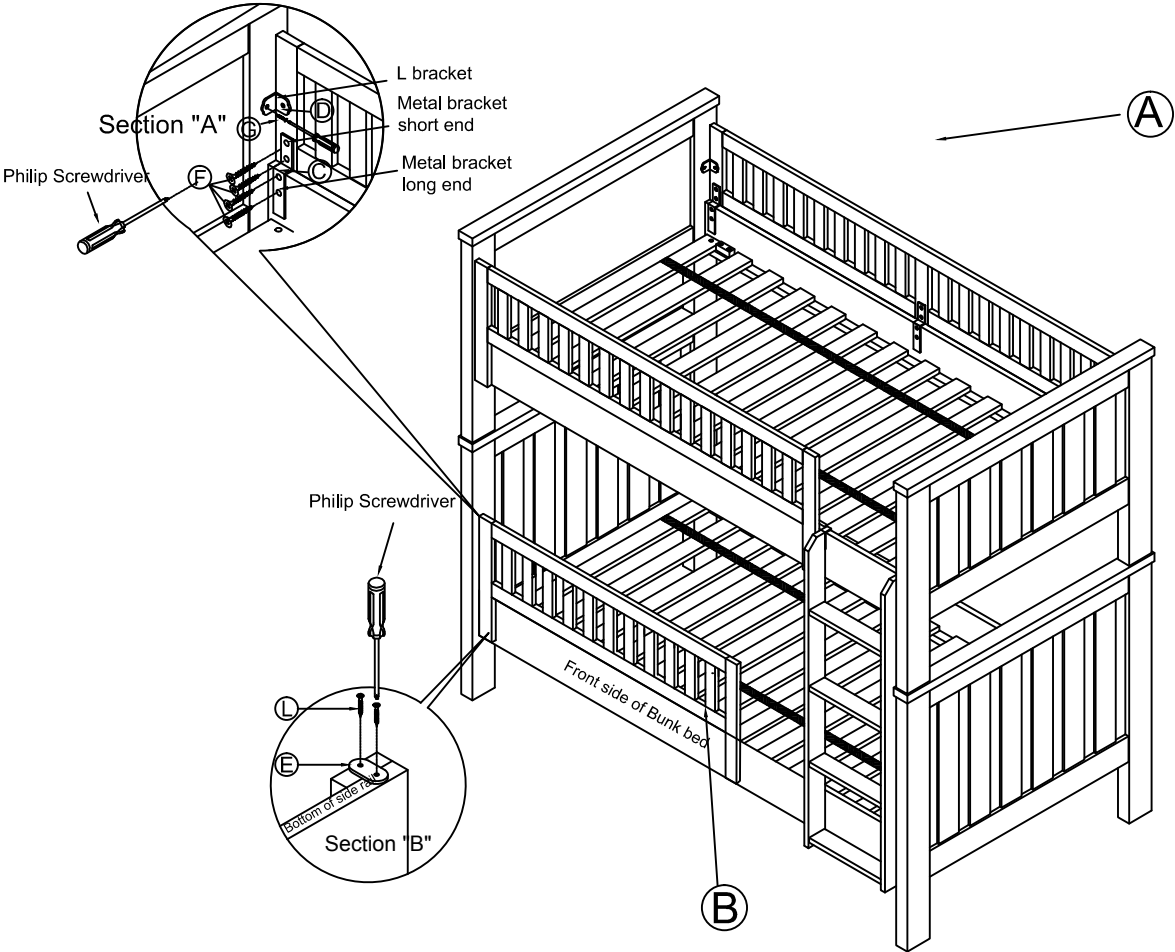

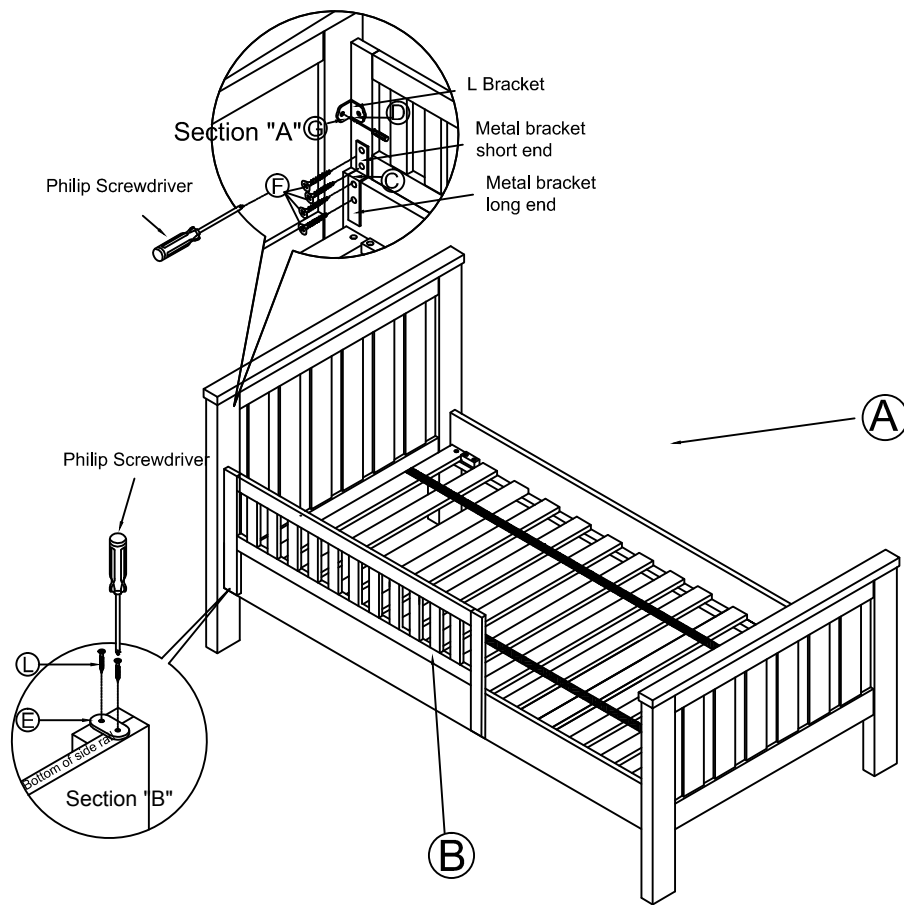

CARE INSTRUCTIONS:

Dust often using a clean, soft ,dry lint-free cloth.

Blot spills immediately, and wipe with a clean, damp, cloth.

We do not recommend the use of chemical cleansers, abrasives, or furniture polish on our lacquered finish