

MERCANTILE OVERSIZED STACKING BIN



WARNING: ADULT ASSEMBLY ONLY OWING TO THE PRESENCE OF SMALL PARTS, SHARP POINTS AND EDGES

PARTS INCLUDED







A [3] Stacking Bin

TOOLS NEEDED

- Phillips head screwdriver (not provided)

ASSEMBLY INSTRUCTIONS

- Place Metal Brackets (1) over the pre-drilled holes on back of middle unit and secure to base and top unit using Wood Screws (2).

NO.	ITEM	DESCRIPTION	QTY.
1		Metal Brackets	4pcs
2		Wood Screws 7x15mm	16pcs
3		Plastic brackets	4pcs
4		Restraint straps	2pcs
5		Phillips screws M4x30mm	4pcs
6		Phillips screws M4x20mm	4pcs
7		Plastic anchors	4pcs

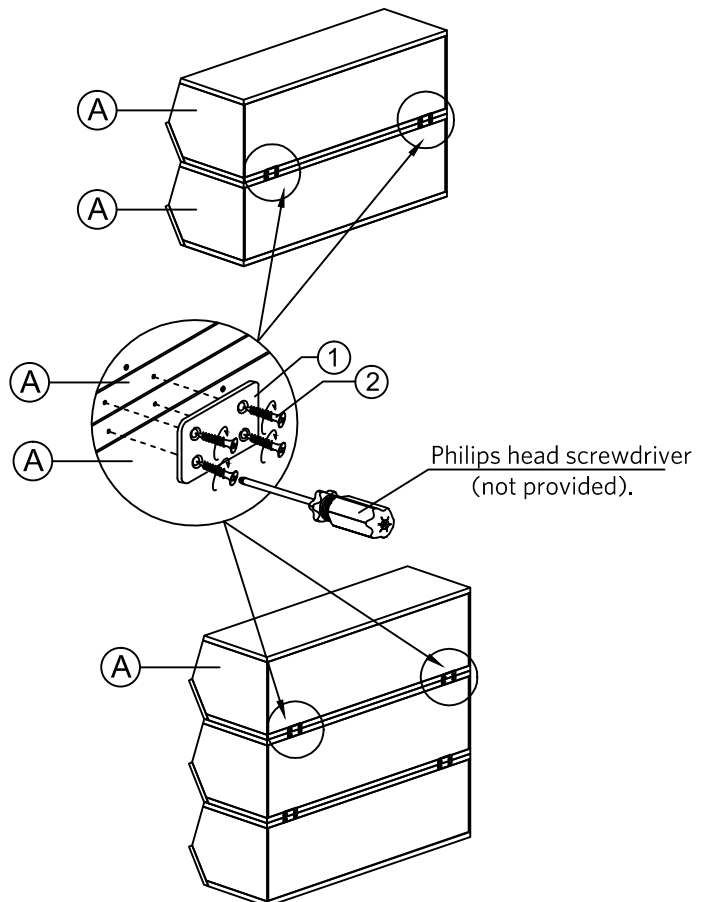
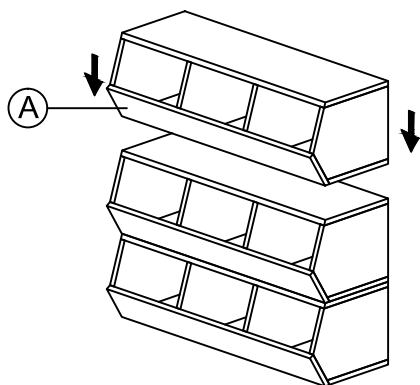
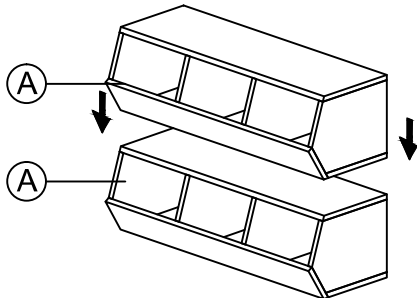

MERCANTILE OVERSIZED STACKING BIN

FURNITURE TIPPING RESTRAINT INSTALLATION:

2. Attach one of the mounting brackets near the top back edge of the furniture piece by inserting the shorter screws.
3. Determine the final position of the furniture piece. Mark location on the wall approximately 2" below the bracket mounted to the back of the furniture.
4. Drill a starter hole into the wall stud. If wall stud is not available, drill a hole into the wall and insert plastic anchor. Gently tap the anchor until the flange of the anchor is flush with the wall.
5. Attach the second bracket by inserting the longer screw through the bracket and into the wall.
6. Place the furniture so the bracket on the back edge is in line with the bracket in the wall.
7. Lace one end of the nylon restraint strap down through each bracket. Bring both ends together and slide the beaded end until it snap locks into the keyhole slot.
8. To double lock; return the beaded end back through the keyholes as shown.
9. Check to make sure the Restraint strap is securely laced and locked to the brackets.

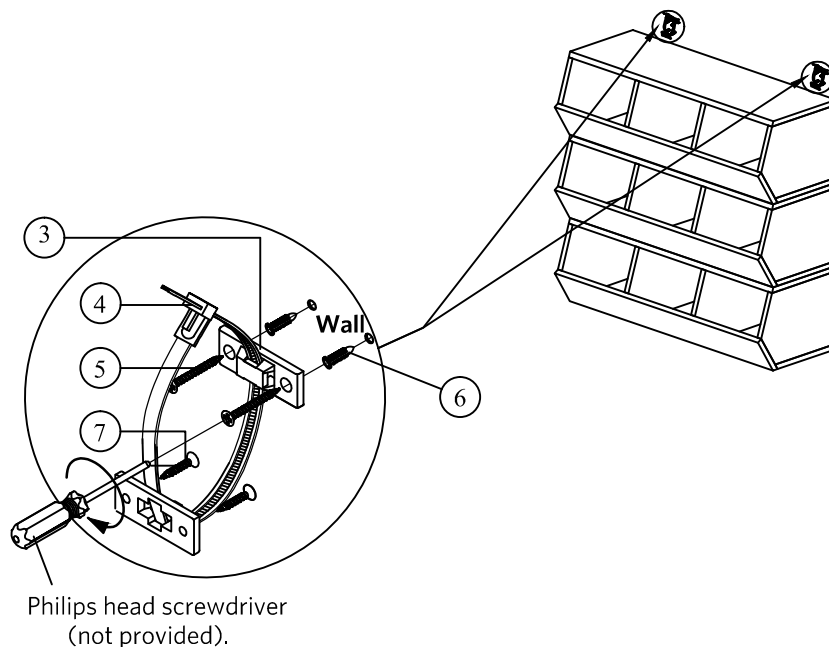

WARNING:

This product is only a deterrent. It is not a substitute for proper adult supervision.
Maximum height is 3 units high.
Please install metal brackets to connect multiple units.

CARE INSTRUCTIONS:

- . Dust often using a clean, soft, dry lint-free cloth.
- . Blot spills immediately, and wipe with a clean, damp cloth.
- . We do not recommend the use of chemical cleansers, abrasives, or furniture polish on our lacquered finish.

Thank you for your purchase
www.rhbabyandchild.com