



PFEIFFER UPHOLSTERED BUNK BED - ASSEMBLY INSTRUCTIONS

Model No: RH419KBK-T/F

Pfeiffer Upholstered Bunk Bed

Made in China



WARNING: Read all instructions before assembling this product.
KEEP INSTRUCTIONS FOR FUTURE USE.

CUSTOMER SERVICE

If you are missing parts or have any questions about this product, contact us first. You can also order parts by writing to the address above. Include the product model number, color, and a brief description of the part. Or call 1-800-762-1751.

CARE AND CLEANING

DO NOT use abrasive chemicals for cleaning. Dust often using a clean, soft, dry cloth. Dab spills quickly with a soft cloth. Vacuum to remove dust.
If the Bunk Bed is to be stored, store in a cool dry place and carefully package all original hardware to protect from loss.

IMPORTANT SAFETY INFORMATION FOR BUNK BED

1. Follow the information on the WARNING label appearing on the upper bunk end structure and on the packing.
Do not remove warning label from bed.
2. Always use the specified size of mattress to help prevent the likelihood of entrapment or falls.
3. Surface of mattress must be at least 5 inches below the upper edge of guardrails on top bunk.
4. Do not allow children under 6 years of age to use upper bunk.
5. Do not allow more than one person on upper bunk.
6. Periodically check and ensure that the guardrails, ladder, and other components are in their proper position, free from damage, and that all connectors are tight.
7. Do not allow horseplay on or under the bed and do not allow jumping on the bed.
8. Always use the ladder for entering and leaving the upper bunk.
9. Do not use substitute parts. Contact RH for replacement parts.
10. Use of a nightlight may provide added safety precaution for a child using the upper bunk.
11. Use guardrails on both sides of the upper bunk.
12. If the bunk bed will be placed next to a wall, the guardrail that runs the full length of the bed should be placed against the wall to prevent entrapment between the bed and the wall.
13. The use of a water flotation mattress is prohibited.
14. STRANGULATION HAZARD - Never attach or hang items to any part of the bunk bed that are not designed for use with the bed, such as hooks, belts, and jump ropes.
15. Keep these instructions for future reference.

WARNING

TO HELP PREVENT

SERIOUS OR FATAL INJURIES FROM ENTRAPMENT OR FALLS

- Never allow a child under 6 years old on upper bunk
- Prohibit horseplay on or under bed(s)
- Prohibit more than one person on upper bunk
- Use ladder for entering and leaving upper bunk
- Use guardrails on both sides of upper bunk
- Use only mattress which is 75" long and 38" wide and 7" height on upper bunk, and mattress which is 75" long and 38" wide and 10" height on lower bunk (twin size)
- Use only mattress which is 75" long and 53" wide and 7" height on upper bunk, and mattress which is 75" long and 53" wide and 10" height on lower bunk (full size)
- Ensure thickness of mattress does not exceed 7" and mattress surface is at least 5" below upper edge of guardrails

STRANGULATION HAZARD

Never attach or hang items to any part of the bunk bed that are not designed for use with the bed, such as hooks, belts and jump ropes.

DO NOT REMOVE THIS LABEL

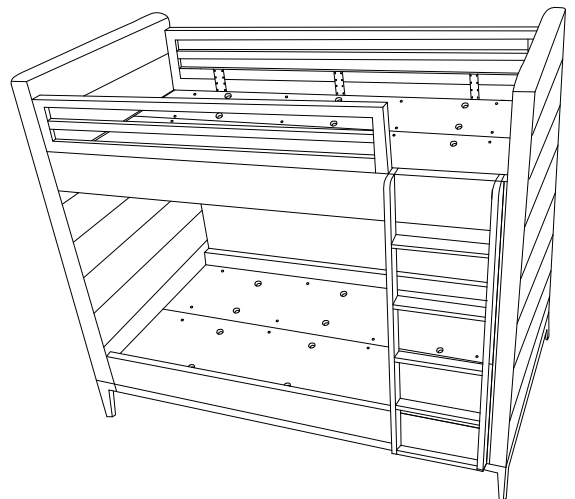

PARTS LIST



(A) Left Bunk End - 1 pc



(B) Right Bunk End - 1 pc



(C) Upper Side Rail - 2 pcs

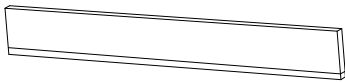

(D) Lower Side Rail - 2 pcs

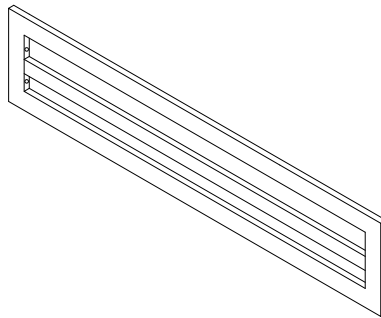

(E) Back Guardrail - 1 pc

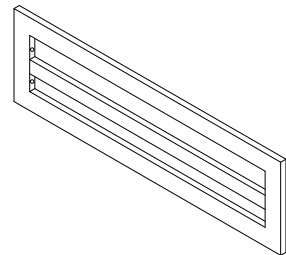

(F) Front Guardrail - 1 pc

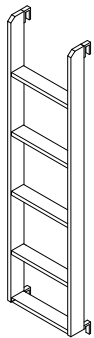

(G) Ladder - 1 pc

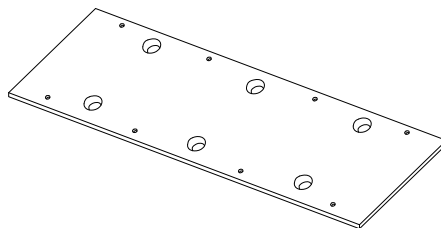



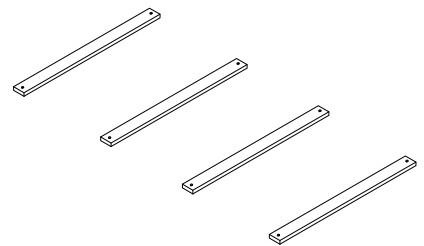





(H) Panel - 4 pcs



(I) Slat Roll - 2 sets

HARDWARE LIST

NO.	HARDWARE ENCLOSED		Qty
1		Threaded Rod	16 pcs
2		Curved Washer	16 pcs
3		Spring Washer	16 pcs
4		Nut	16 pcs
5		Spanner Wrench	1 pc
6		Screw (3cm)	32 pcs
7		Screw (4cm)	16 pcs
8		Allen Key (0.5cm diam.)	1 pc
9		Allen Key (0.4cm diam.)	1 pc
10		Allen Key	1 pc
11		Allen Head Bolt (0.6cm diam.)	8 pcs
12		Screw (2.5cm)	28 pcs
13		Metal plate	6 pcs
14		Allen Head Bolt (6.5cm)	6 pcs
15		Allen Head Bolt (2.1cm)	20 pcs

TOOLS NEEDED:

Phillips-head screwdriver (not included) 

ASSEMBLY INSTRUCTIONS

Note:

- Bed must be assembled by at least two people.
- Please read instructions carefully before assembling bed.
- Use the above parts and fittings list to identify each component.
- Keep all packing materials until assembly is complete to avoid loss of smaller parts.
- Do not completely tighten all bolts until all steps are finished.

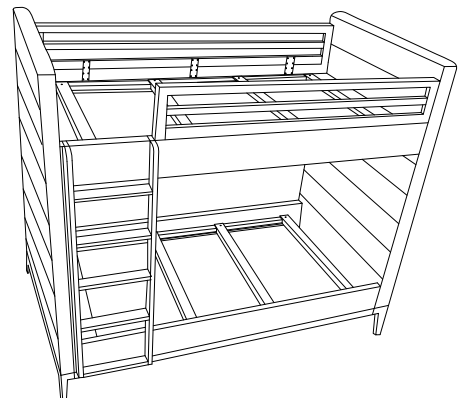

Process:

Step 1: Attach Upper Side Rail (C) and Lower Side Rail (D) to Left Bunk End (A) and Right Bunk End (B).

Stand Right Bunk End (B) upright and insert Thread Rod (1) into the prefabricated holes. Then align Lower Side Rail (D) with the protruding metal base part of Right Bunk End (B) inserted into the tube of Lower Side Rail (D) and Thread Rod (1) into the holes in Side Rail (D). Attach Curved Washer (2), Spring Washer (3) and Nut (4) onto Thread Rod (1) and Tighten Nut (4) with Spanner Wrench (5), as shown in Diagram II. Tighten Allen Head Bolt (11) with Allen Key (9), as shown in Diagram I.

Repeat the procedure to attach Lower Side Rail (D) to Left Bunk End (A).

Repeat the procedure to attach Upper Side Rail (C) to Left Bunk End (A) and Right Bunk End (B).

Step 2: Lay the Slat (I) in between Upper Side Rail (C) and then tighten with Screw (7), as shown in Diagram III.

Repeat the procedure to tighten Slat (I) between Lower Side Rail (D).

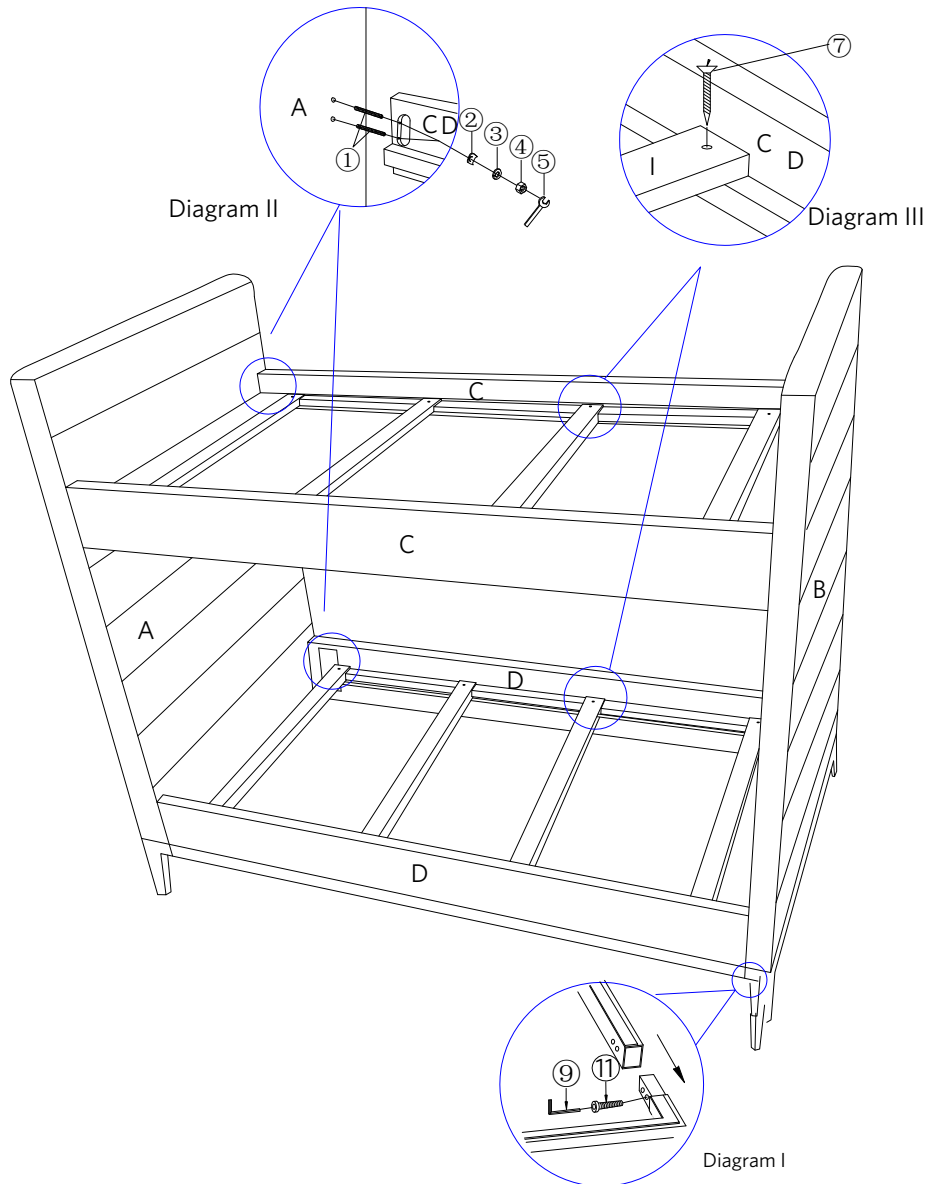

Step 3: Attach Back Guardrail (E) to Left Bunk End (A) and Right Bunk End (B). Use the Allen Key (10) to tighten Allen Head Bolt (14).

Step 4: Attach Front Guardrail (F). Use the Allen Key (10) to tighten Allen Head Bolt (14), as shown in Diagram IV.

For Bunks with Ladder on Left side, attach Front Guardrail (F) to the Right Bunk End (B), so the ladder sits on Left.

For Bunks with Ladder on the Right Side, attach Front Guardrail (F) to the Left Bunk End (A), so the ladder sits on Right.

Step 5: Reinforce the Back Guardrail (E) and Front Guardrail (F) with Metal Plate (13) and tighten with Screw (12) and Allen Head Bolt (15), as shown in Diagram V.

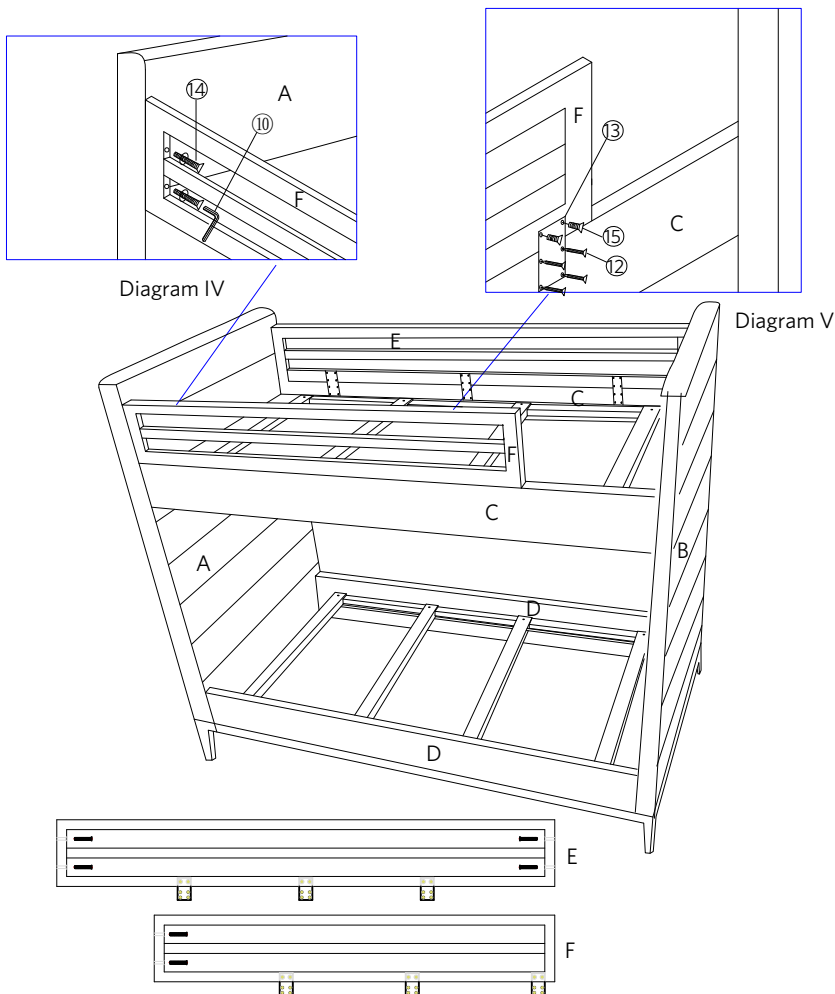

Step 8: Install Bedding:

BEDDING SPECIFICATIONS:

The following mattress and foundation sizes are specified for use with this Bunk Bed:

MATTRESS: 38"W × 75"L × 7"H on upper bunk, 38"W × 75"L × 10"H on lower bunk (twin size)
53"W × 75"L × 7"H on upper bunk, 53"W × 75"L × 10"H on lower bunk (full size)

PLATFORM PANEL: CONSISTING OF 4 PANELS: 73.8"W × 18.6"L × 0.7"H (twin size)
73.8"W × 26.1"L × 0.7"H (full size)

**** Note:** MATTRESS AND PLATFORM PANEL MUST NOT EXCEED 9" TOTAL THICKNESS FOR UPPER BUNK.

Be sure to adhere to these BEDDING SPECIFICATIONS in order to avoid the possibility of falling or entrapment.

THESE SPECIFICATIONS MUST BE STRICTLY ADHERED TO!

FULL BUNK MATTRESS DIAGRAM

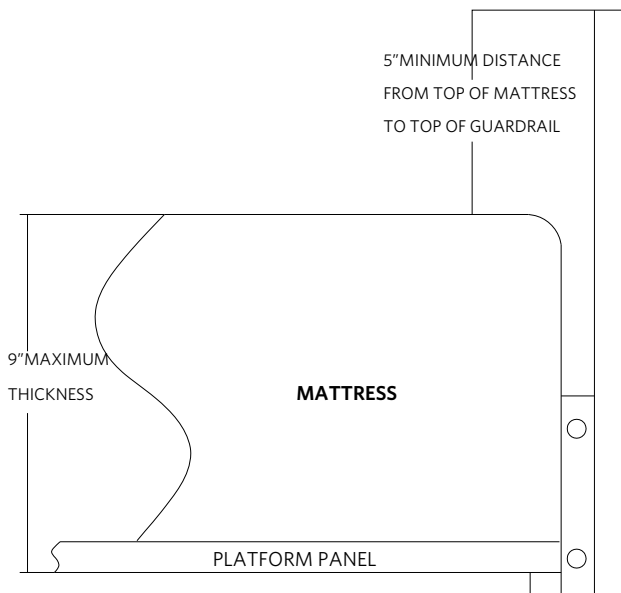

Thank you for your purchase

www.rhbabvandchild.com

⚠ WARNING

TO HELP PREVENT

SERIOUS OR FATAL INJURIES FROM ENTRAPMENT OR FALLS

- Never allow a child under 6 years old on upper bunk
- Prohibit horseplay on or under bed(s)
- Prohibit more than one person on upper bunk
- Use ladder for entering and leaving upper bunk
- Use guardrails on both sides of upper bunk
- Use only mattress which is 75" long and 38" wide and 7" height on upper bunk, and mattress which is 75" long and 38" wide and 10" height on lower bunk (twin size)
- Use only mattress which is 75" long and 53" wide and 7" height on upper bunk, and mattress which is 75" long and 53" wide and 10" height on lower bunk (full size)
- Ensure thickness of mattress does not exceed 7" and mattress surface is at least 5" below upper edge of guardrails

STRANGULATION HAZARD

Never attach or hang items to any part of the bunk bed that are not designed for use with the bed, such as hooks, belts and jump ropes.

DO NOT REMOVE THIS LABEL