

RHBABY&CHILD

WILKES TRUNK WIDE DRESSER INSTRUCTIONS

Made in Vietnam

Distributed in the U.S.A. by:

Restoration Hardware Baby & Child

2900 North Macarthur Dr. Tracy, CA95376, USA

www.rhbabyandchild.com

Distributed in Canada by:

Restoration Hardware Canada, Inc.

1500-1055 West Georgia Street Vancouver, British Columbia V6E4N7

FURNITURE TIPPING RESTRAINT INSTRUCTIONS

Young children may be injured by tipping furniture. The use of a tipping restraint is highly recommended.

When properly installed, this restraint could provide protection against the unexpected tipping of furniture due to small tremors, bumps or climbing. We recommend mounting this restraint to a wall stud.

WARNING: This product is only a deterrent. It is not a substitute for proper adult supervision.

INSTALLATION INSTRUCTIONS

1. Attach two of the mounting brackets (1) near the top back edge of the dresser by inserting the shorter screws(4).
2. Determine the final position of the dresser. Mark locations on the wall approximately 2" below the brackets mounted to the back of the dresser.
3. Drill a shorter hole into the wall stud. If wall stud is not available, drill a hole into the wall and insert plastic anchor (5). Gently tap the anchor until the flange is flush with the wall.
4. Attach the second set of brackets (1) by inserting the longer screw (3) through the bracket (1) and into the wall.
5. Place the furniture so that the brackets on the back edge are in line with the brackets in the wall.
6. Lace one end of the nylon restraint strap (2) down through each bracket. Bring both ends together and slide the beaded end until it snap locks into the keyhole slot.
7. To double lock; return the beaded end back through the keyholes as shown.
8. Check to make sure the straps are securely laced and locked to the brackets.
9. Repeat all above step for attach other tip-kit position.

CARE INSTRUCTIONS

1. Dust often using a clean, soft, dry and lint-free cloth.
2. Blot spills immediately and wipe with a clean, damp, cloth.
3. We do not recommend the use of chemical cleansers, abrasives or furniture polish on our lacquered finish.

IMPORTANT SAFETY INSTRUCTIONS



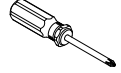

1. Please read all instructions carefully before assembling.
2. For your safety, assembly by two or more adults is strongly recommended.
3. Keep instructions for future use.
4. Use only vendor supplied hardware to assemble. Using unauthorized hardware could jeopardize the structural integrity of the item.

TOOLS NEEDED

Phillips Screwdriver (Not provided)



HARDWARE INCLUDED

NO.	ITEM	DESCRIPTION	QTY.
1		Plastic Bracket	4 pcs.
2		Restraint Strap	2 pcs.
3		Phillips Screws M4 x 30mm	4 pcs.
4		Phillips Screws M4 x 20mm	4 pcs.
5		Plastic Anchor	4 pcs.

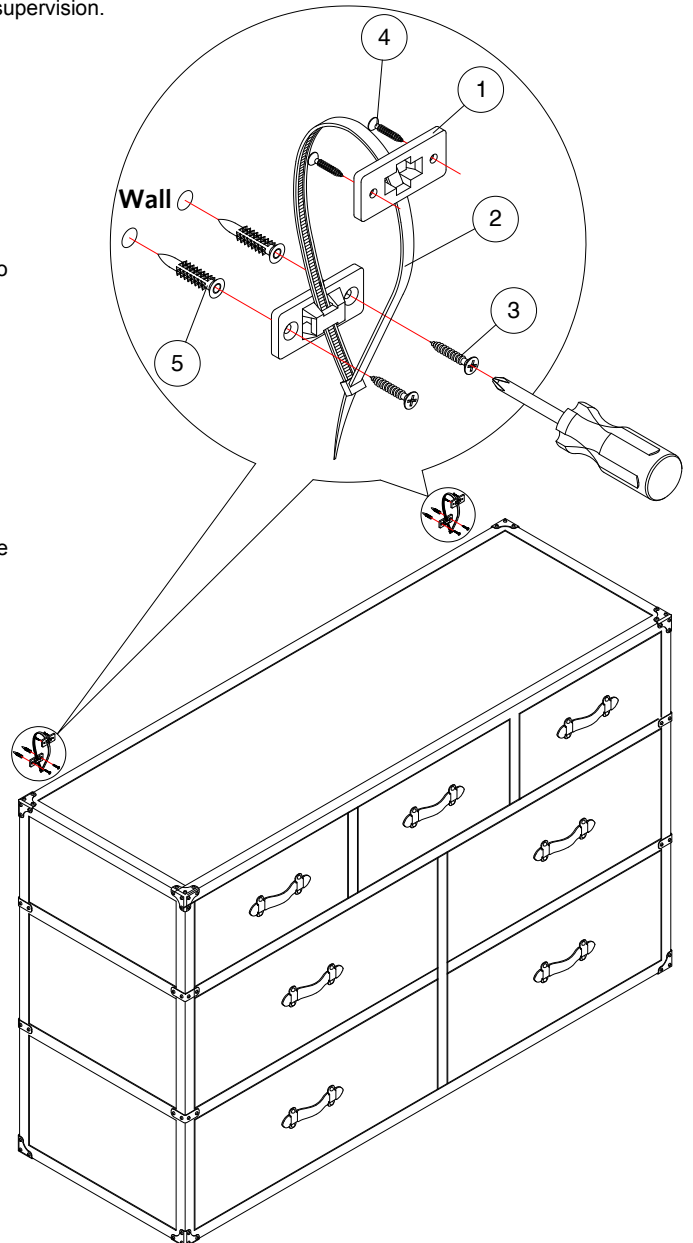

RHBABY&CHILD

WILKES TRUNK WIDE DRESSER TOPPER INSTRUCTIONS

Made in Vietnam

Distributed in the U.S.A. by:

Restoration Hardware Baby & Child

2900 North Macarthur Dr. Tracy, CA95376, USA

www.rhbabyandchild.com

Distributed in Canada by:

Restoration Hardware Canada, Inc.

1500-1055 West Georgia Street Vancouver, British Columbia V6E4N7

WARNING

- * Adult assembly only owing to the presence of small parts, sharp points and edges.
- * **FALL HAZARD** - To prevent death or serious injury from falls, always keep child within arms reach.
- * The surface used should be level, stable, structurally sound, with a minimum surface dimension of 45" by 20".
- * Read all instructions before use of the item.
- * Keep the instructions for future reference.
- * Do not use the changing system if it is damaged or broken.
- * This changing system is intended to use with children weighing up to 30 lbs.
- * Cushion pads size is 32" W x 16" D x 4"H.

CAUTION

WHEN CHILD REACHES A MAXIMUM WEIGHT OF 30 LBS. THE CHANGING TABLE SHALL NO LONGER BE USED.

PARTS INCLUDED

A [1] DRESSER

B [1] TOPPER

ASSEMBLY INSTRUCTIONS

1. Lift up the topper [B] and gently place on top of the dresser [A], check the distance on both sides of the topper [B] to make sure it is centered correctly.
2. After checking the distance on both sides, engage the metal mending plates [1] at the back of the topper [B] and the dresser [A] using screws [2] provided.

CARE INSTRUCTIONS

1. Dust often using a clean, soft, dry and lint-free cloth.
2. Blot spills immediately and wipe with a clean, damp, cloth.
3. We do not recommend the use of chemical cleansers, abrasives or furniture polish on our lacquered finish.

IMPORTANT SAFETY INSTRUCTIONS



1. Please read all instructions carefully before assembling.
2. For your safety, assembly by two or more adults is strongly recommended.
3. Keep instructions for future use.
4. Use only vendor supplied hardware to assemble. Using unauthorized hardware could jeopardize the structural integrity of the item.

TOOLS NEEDED

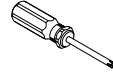
Phillips Screwdriver
(Not provided)



HARDWARE INCLUDED

NO.	ITEM	DESCRIPTION	QTY.
1		Mending Plate	2 pcs.
2		Phillips Screws M4 x 12mm	8 pcs.

