



**WARNING**

Young children may be injured by tipping furniture, and proper installation of the mounting hardware for this item is highly recommended. When properly installed, this mounting hardware could provide protection against the unexpected tipping of this furniture piece. We recommend mounting to a wall stud if possible.

**PARTS INCLUDED**

- A [1] UPPER PART
- B [1] BOTTOM PART







**TOOLS NEEDED**

Phillips Head Screwdriver (not included)

**ASSEMBLY INSTRUCTIONS**

Two people are recommended for easy assembly. These instructions are written assuming two people are assembling the unit.

1. Carefully unpack the contents of the carton.
2. Position the Upper Part (A) over the Bottom Part (B).
3. Insert the Screws (2) into the slots on the Metal Connector (1), secure it with Screwdriver (not included) and repeat this procedure with the other Metal Connector (1).
4. Place two of the Plastic Brackets (3) near the top back edge of the furniture, insert the Short Screw (6) and tighten with Screwdriver (not included).
5. Drill two holes in line with the Plastic Brackets (3) on the back side of the furniture piece, insert the Plastic Anchor (7) and attach the second set of Plastic Brackets (3) to the wall by inserting the Long Screw (5).
6. Lace one end of the Restraint Strap (4) down through each Plastic Bracket (3), bring both ends together and slide the beaded end until its snap locks into the keyhole slot as shown in the sketch.

NO.	ITEM	DESCRIPTION	QUANTITY
1		Metal Connector	2pcs.
2		Screw	6pcs.
3		Plastic Bracket	4pcs.
4		Restraint Strap	2pcs.
5		Long Screw	4pcs.
6		Short Screw	4pcs.
7		Plastic Anchor	4pcs.

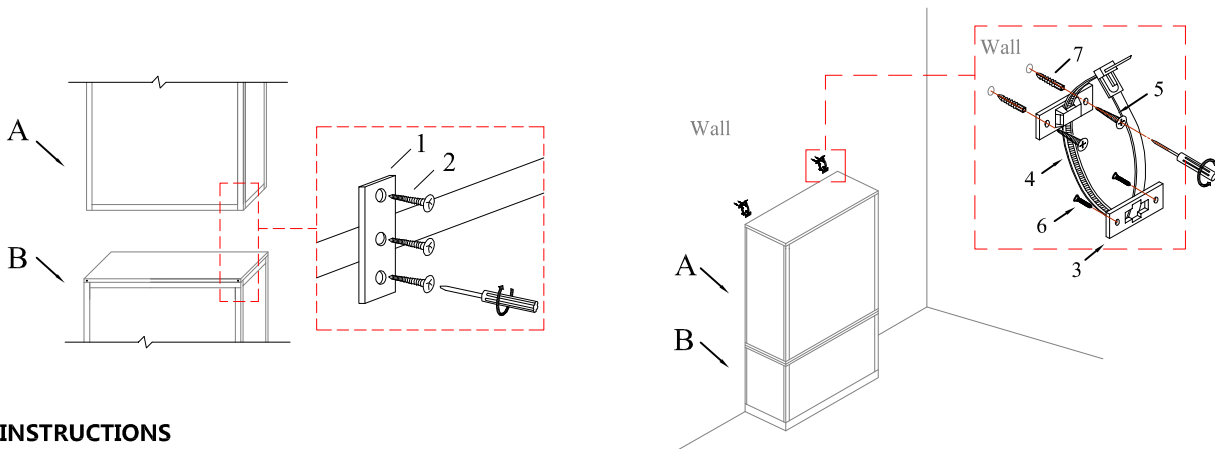

**CARE INSTRUCTIONS**

1. Clean periodically by wiping the furniture lightly with a soft, clean cloth.
2. We don't recommend using abrasive or chemical cleaners as they may damage the finish.