

baby&child

RESTORATION HARDWARE

CLASSIC TACK LINEN MEMORY BOARD (40"x 60")

PARTS INCLUDED

1. MEMORY BOARD
2. ALUMINUM HANGER
3. ANTI-TIP BRACKET

ASSEMBLY INSTRUCTIONS





A) Wall Mounting

1. Unpack all parts, and place them on a protected work surface.
2. Determine the exact location of the memory board, and mark the holes on the wall surface using the holes in the aluminum hanger (3) as a guide.
3. Drill small holes on each point location on the wall. Each hole should be just large enough to accommodate plastic anchor (2).
4. Insert the plastic anchor (2) into the holes on the wall.
5. Mount the aluminum hanger into the wall using screw (1).
6. Check that the aluminum hanger fixture is securely screwed into the wall.
7. Place the memory board with hanger cleat into the aluminum hanger fixture.
8. Installation is complete.

B) Leaning

1. Position the memory board, and firmly attach anti-tip brackets (5) to the wall in line with the bracket on the unit, and hang up the memory board.
2. Thread the strap provided through both brackets as shown, and tighten strap unit until it is snug. Do not over tighten.

Note: When leaning the board, we recommend fastening the preinstalled, anti-tip hardware on the back to the wall. When hanging, simply follow the instructions above. The anti-tip brackets are not necessary.

NO	ITEM	DESCRIPTION	QTY
1		Screw	9 pcs.
2		Plastic Anchor	6 pcs.
3		Aluminum Hanger	1 pc.
4		Aluminum Hanger	1 pc.
5		Anti-Tip Bracket	2 pcs.

A:

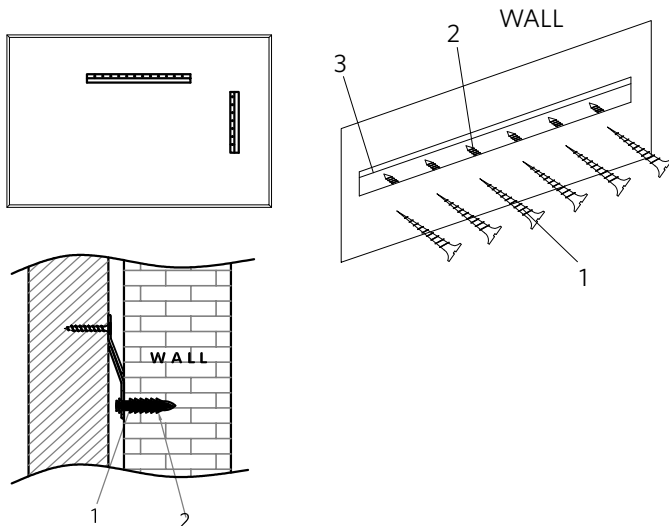

B:

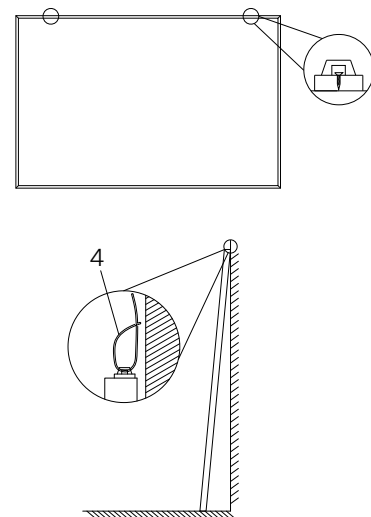

CARE INSTRUCTIONS

1. To clean, use a soft dry or damp cloth.
2. Do not use abrasive cleanser.

IMPORTANT SAFETY INSTRUCTIONS

1. These instructions are provided for your safety. It is important that they are read carefully and completely before installation of the fixture. Professional installation is strongly recommended.
2. Check with a professional to ensure your wall can tolerate a fixture weighing 41 lbs.
3. For your safety, it is recommended that two people hang the fixture.