

RHBABY&CHILD

THAYER BOOKCASE INSTRUCTIONS

Restoration Hardware Baby & Child
2900 North Macarthur Dr.
Tracy, CA 95376, USA









Restoration Hardware Canada, Inc.
1500-1055 West Georgia St.
Vancouver, British Columbia V6E 4N7

PARTS INCLUDED

- A [1] BOOKCASE
- B [2] REMOVABLE SHELF PANELS

ASSEMBLY INSTRUCTIONS

1. Remove all the shelf panels (B) from the bookcase (A). Pre-set the bookcase in desired location. Check the leveling, and adjust the levelers underneath the legs if necessary. See FIGURE 1.
2. From desired height of the shelf panels, insert the metal shelf holders (1) into the bore holes at the inside surface of the side panels.
3. Set the shelf panels on the shelf holders. Install screws (2) to fix the shelf panels to the metal shelf holders. See FIGURE 2.

| NO. | ITEM | DESCRIPTION | QTY. |
|-----|---|--------------------------------|--------|
| 1 |  | Shelf Holder | 8 pcs. |
| 2 |  | Round Head Screws M4 x 15mm | 8 pcs. |
| 3 |  | Metal Bracket | 2 pcs. |
| 4 |  | Clevis Pin | 2 pcs. |
| 5 |  | Steel Aircraft cable | 1 pc |
| 6 |  | Hair Pin | 2 pcs. |
| 7 |  | Short Screw | 2 pcs. |
| 8 |  | Long Screw | 2 pcs. |
| 9 |  | Toggle bolt | 2 sets |

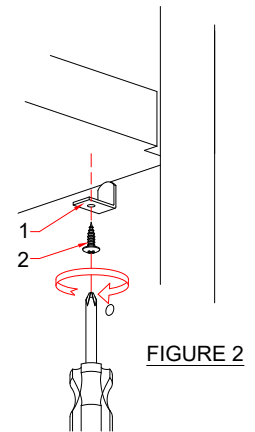
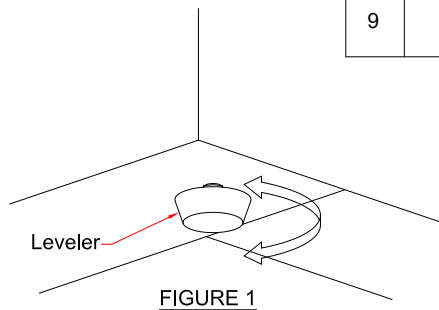
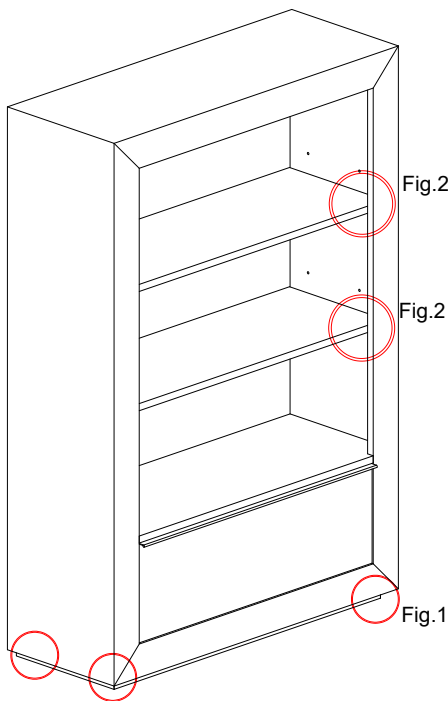

ASSEMBLY INSTRUCTIONS BY WALL TYPE :

- DRYWALL WITH STUDS: Use screws to affix to studs, and use hollow wall anchors and screws to affix to drywall. See FIGURE A.
- DRYWALL WITHOUT STUDS: Use toggle bolt and screws to affix to drywall. See FIGURE B.

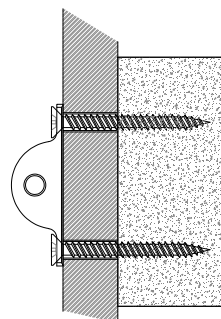

FIGURE A
DRYWALL W/STUDS

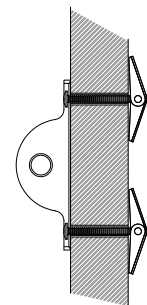

FIGURE B
DRYWALL W/O STUDS

RH BABY & CHILD

THAYER BOOKCASE INSTRUCTIONS

FURNITURE TIPPING RESTRAINT INSTRUCTIONS

Young children may be injured by tipping furniture. The use of a tipping restraint is highly recommended.

When properly installed, this restraint could provide protection against the unexpected tipping of furniture due to small tremors, bumps or climbing. We recommend mounting this restraint to a wall stud.

WARNING: This product is only a deterrent. It is not a substitute for proper adult supervision.

ANTI-TIP-KIT INSTALLATION INSTRUCTION

⚠ WARNING: Always mount metal brackets to solid wood of furniture. Do not attach to plywood of back panels. Always locate and attach to studs. Do not depend on wall anchors.

1. Attach mounting brackets (3) near the middle-top back edge of the furniture piece by inserting the shorter screws (7).
2. Determine the final position of the furniture piece. Mark locations on the wall approximately 2" below the brackets mounted to the back of the furniture.
3. Attach the second brackets by inserting the longer screw (8) or toggle bolt (9) or plastic anchor (DEPEND ON YOUR WALL TYPE) through the bracket and into the wall.
4. Place the furniture so that the brackets on the back edge are in line with the brackets in the wall.
5. Insert the clevis pin (4) through holes on brackets and hole on steel aircraft cable (5). Using hair pin (6) to go through small hole on clevis pin (4) to lock it.
6. Repeat above step to attach the end of air craft cable (5) to the bracket on the wall.
7. Check to make sure the steel aircraft cable are securely laced and locked to the brackets.

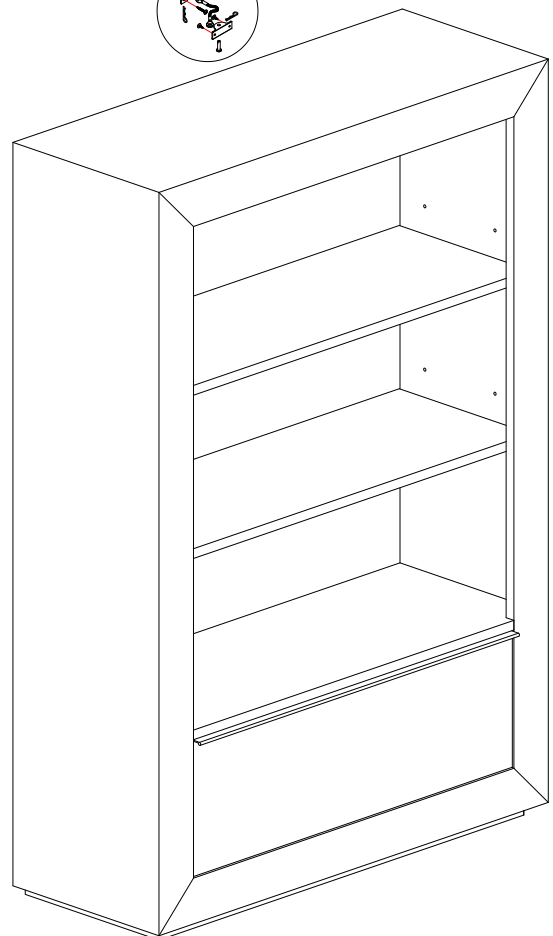
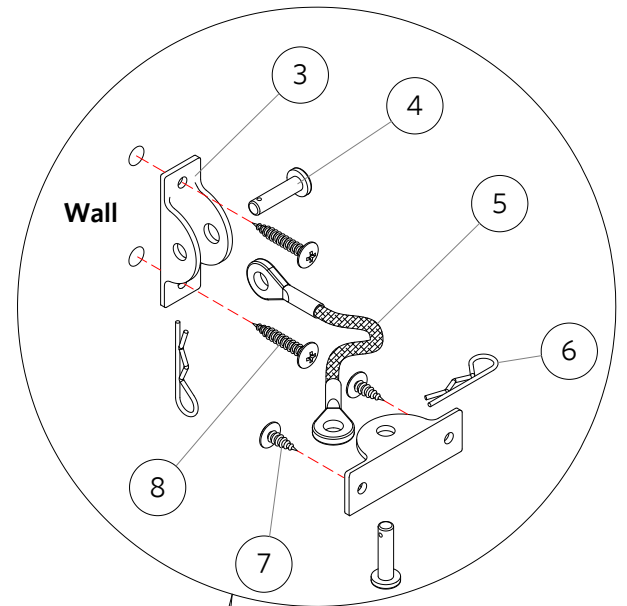

CARE INSTRUCTIONS

1. Dust often using a clean, soft, dry and lint-free cloth.
2. Blot spills immediately and wipe with a clean, damp, cloth.
3. We do not recommend the use of chemical cleansers, abrasives or furniture polish on our lacquered finish.

IMPORTANT SAFETY INSTRUCTIONS

1. Please read all instructions carefully before assembling.
2. For your safety, assembly by two or more adults is strongly recommended.
3. Keep instructions for future use.
4. Use only vendor supplied hardware to assemble. Using unauthorized hardware could jeopardize the structural integrity of the item.