

RHBABY&CHILD

BELLINA LOW-PROFILE CONVERSION TODDLER BED KIT INSTRUCTIONS

Made in Vietnam

Distributed in the U.S.A. by:

Restoration Hardware Baby & Child

11640 Harrel St. Suite B

Mira Loma, CA 91752

www.rhbabyandchild.com

Distributed in Canada by:

Restoration Hardware Canada, Inc.

1500-1055 West Georgia Street

Vancouver, British Columbia V6E4N7

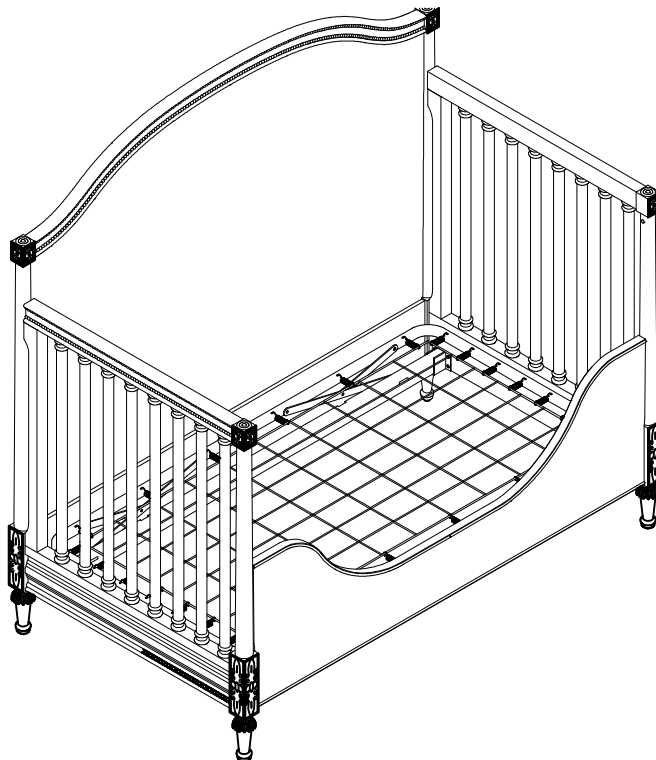

WARNING: Read all instructions before assembling this product. **KEEP INSTRUCTIONS FOR FUTURE USE.**

CUSTOMER SERVICE

If you are missing parts or have any questions about this product, contact us first. You can also order parts by writing to the address above. Include the product model number, color, and a brief description of the part. Call 1-800-762-1751.

CARE AND CLEANING

DO NOT scratch or chip the finish. DO NOT use abrasive chemicals for cleaning. Dust often using a clean, soft, dry cloth. Blot spills immediately and wipe with a clean damp cloth. If the crib is to be stored, store in a cool dry place and carefully package all original hardware to protect from loss.

TOOLS AND INSTALLATION

Tools Necessary: Allen Key (included)

NOTE: It may be easier to assemble product with two people.

NOTE: When inserting bolts, turn clockwise until tight. Then loosen $\frac{1}{2}$ - $\frac{3}{4}$ of a turn. After crib is completely assembled, return to each bolt and tighten. Use wax or soap on all bolts to facilitate assembly

WARNING: ENTRAPMENT / STRANGULATION HAZARD

Infants have died in toddler beds from entrapment and strangulation.

Failure to follow these warnings and the assembly instructions could result in serious injury or death.

NEVER use bed with children under 15 months.

NEVER place bed near windows where cords from blinds or drapes may strangle a child.

- The mattress intended for use on the bed shall be a full-size crib mattress having minimum dimensions of 51-5/8 inches (1310mm) in length, 27-1/4 inches (690mm) in width and 4 inches (100 mm) in thickness, not exceeding 6 inches (152 mm) in thickness.
- If guardrails are used as the mattress containment means, guardrail(s) provided must be used to avoid the formation of a gap between the mattress and the bed that could cause an entrapment.
- **DO NOT** place bed near windows where cords from blinds or drapes may strangle a child.
- **DO NOT** place items with a string, cord, or ribbon around a child's neck, such as hood strings or pacifier cords.
- **DO NOT** suspend strings over a toddler bed for any pacifier cords.
- A child using the toddler or day bed shall be at least 15 months of age and shall not weigh more than 50lbs (22.7kgs).



WARNING: ADULT ASSEMBLY ONLY, OWING TO THE PRESENCE OF SMALL PARTS, SHARP POINTS AND EDGES.

CAUTION

TODDLER BED: THE MINIMUM AGE SHALL NOT BE LESS THAN 15 MONTHS AND THE MAXIMUM WEIGHT SHALL NOT BE GREATER THAN 50LBS. (22.7 KG).

THE MATTRESS INTENDED FOR USE ON THE BED SHALL BE A FULL-SIZE CRIB MATTRESS HAVING MINIMUM DIMENSIONS OF 51-5/8 IN. (1310MM) IN LENGTH, 27-1/4 IN.(690MM)IN WIDTH AND 4 IN. (100MM) IN THICKNESS NOT EXCEEDING 6 IN. (152MM) IN THICKNESS.

CARE INSTRUCTIONS:

- Dust often using a clean, soft, dry, lint- free cloth.
- Blot spills immediately, and wipe with a clean, damp cloth.
- We do not recommend the use of chemical cleaners, abrasives, or furniture polish on our lacquered finish.

PART LIST

- A. BELLINA CONVERSION HEADBOARD
- B. BELLINA CONVERSION END RAIL PANELS
- C. BELLINA CONVERSION TODDLER BED KIT
- D. MATTRESS SUPPORT

**TODDLER CONVERSION KIT
ASSEMBLY HARDWARE IS
INCLUDED IN THE TODDLER
KIT BOX.**

HARDWARE

(EE) 1/4" x 1/2" BOLT = 2 PCS.

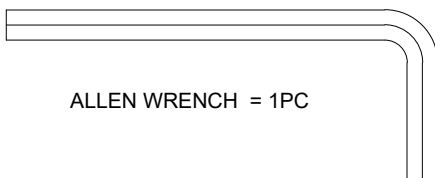
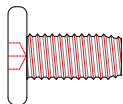

ALLEN WRENCH = 1PC

ASSEMBLY INSTRUCTIONS

STEP #1.

FRONT RAIL DISASSEMBLY.

STEP #1.1:

Remove the Front Rail Panel of the crib by loosening all the bolts installed, as in DETAIL A.

STEP #1.2:

Gently tilt the Crib and release the bolts underneath the metal brackets holding the Stabilizer Rails as in DETAIL B.

NOTE:

- Slightly loosen the bolt at the back of the Headboard that enough to set the Toddler Tail in-between End Rail Panels.

DETAIL A

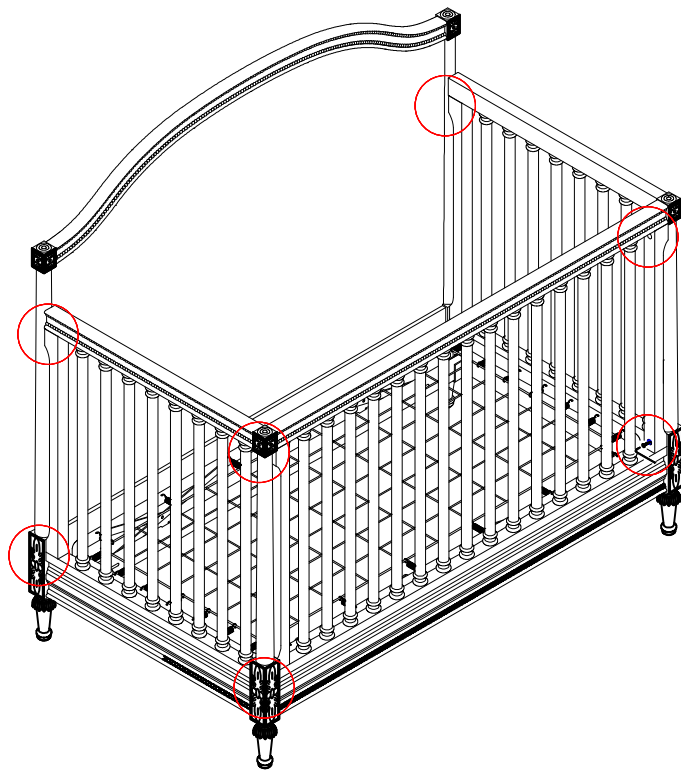
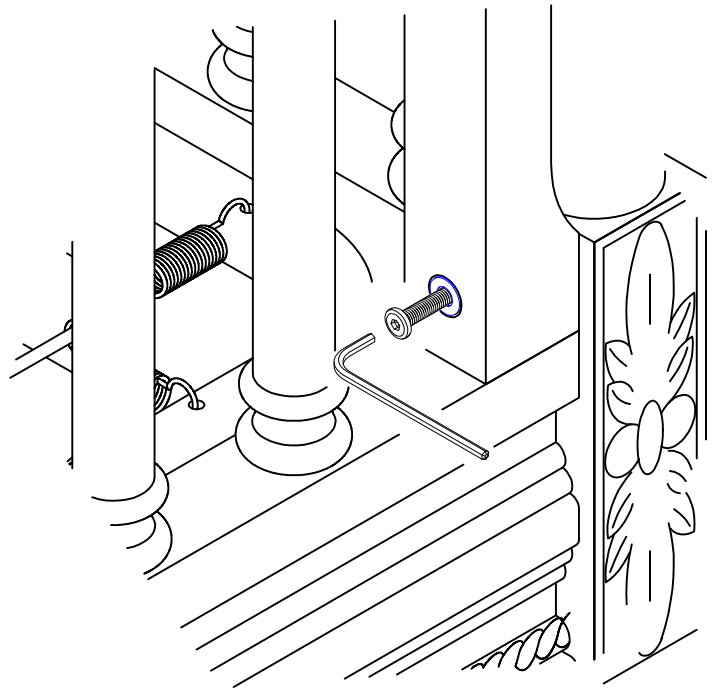

DETAIL B

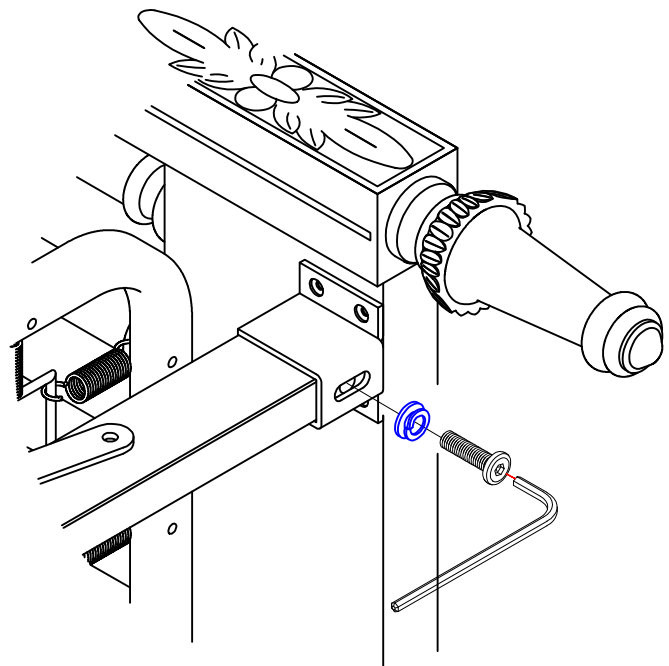

STEP #2.

TODDLER RAIL ASSEMBLY.

STEP #2.1

On inside face of both End Rail Panels there is a cavity for the hook which corresponds to the hook on both end of the Toddler Rail. Align and insert the hook of the Toddler Rail into the cavity of the End Rail Panel, as in DETAIL C.

STEP #2.2

Fill the holes located on the top of both end of the side panel by inserting bolt (EE) provided.

DETAIL C

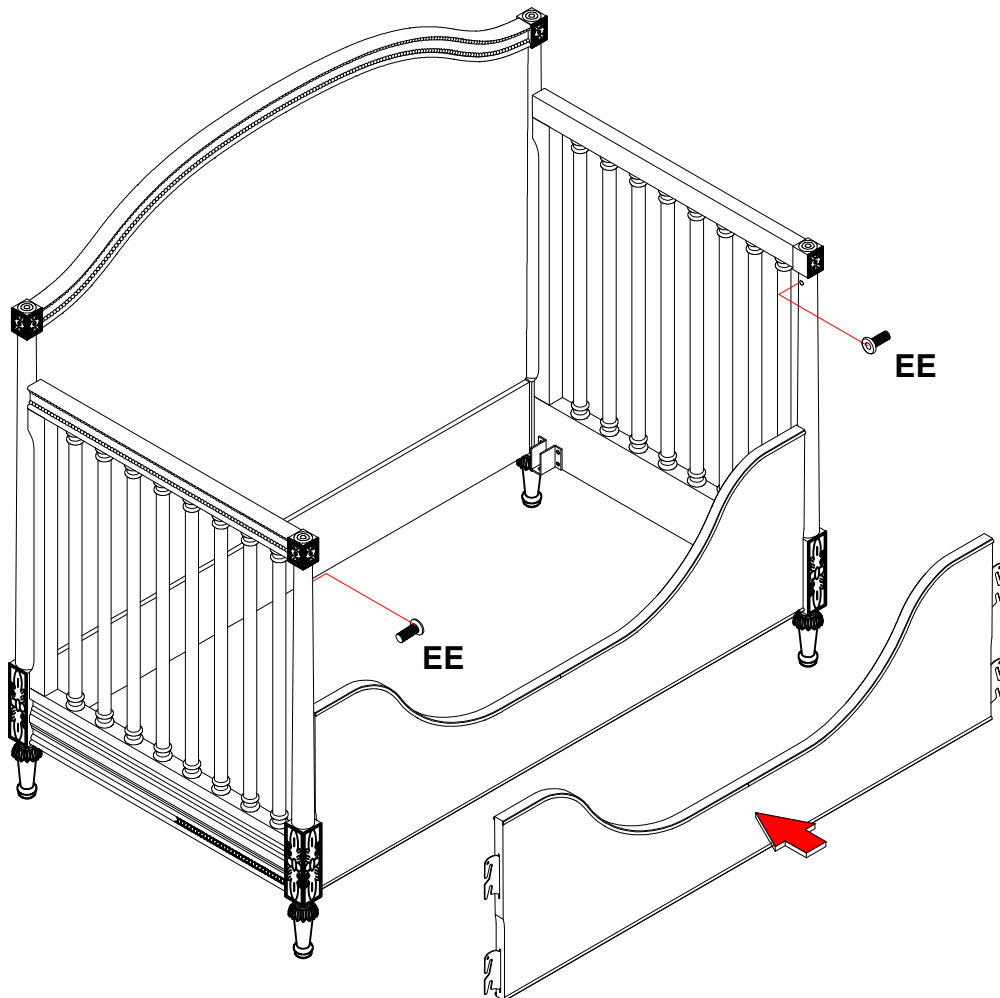
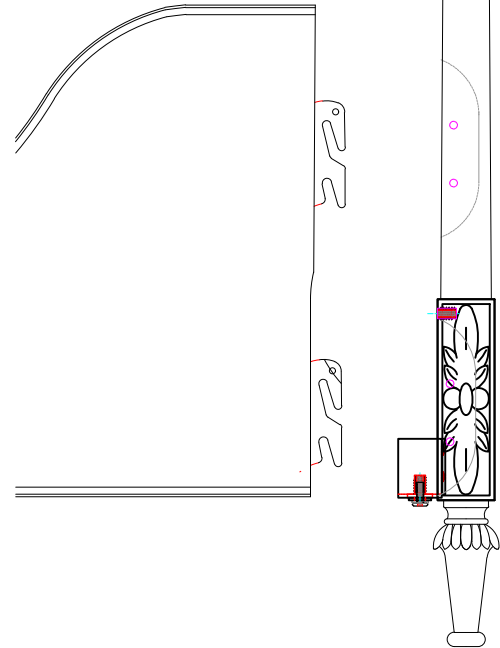

STEP #3

MATTRESS SUPPORT HEIGHT ADJUSTMENT

NOTE: If mattress supports is not in the lowest position.

STEP #3.1

Loosen and remove all hardware (BB) on both sides of the frame of mattress support.

STEP #3.2

Re-install the bolt on the third hole of the frame through the hole on the arm support. Fasten the bolt with plain washers, lock washers & hexagonal nut. Repeat procedure on the other arms of the mattress support. See DETAIL D & DETAIL E.

DETAIL D

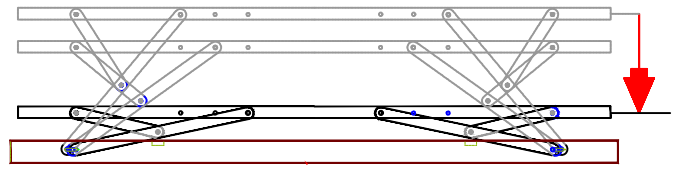

DETAIL E

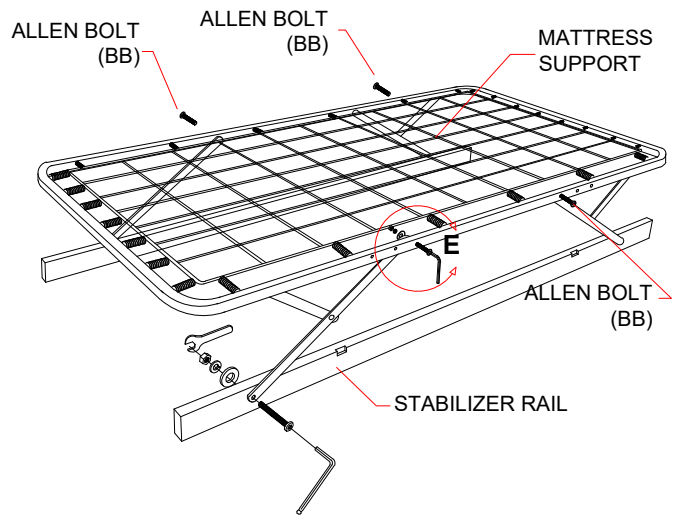
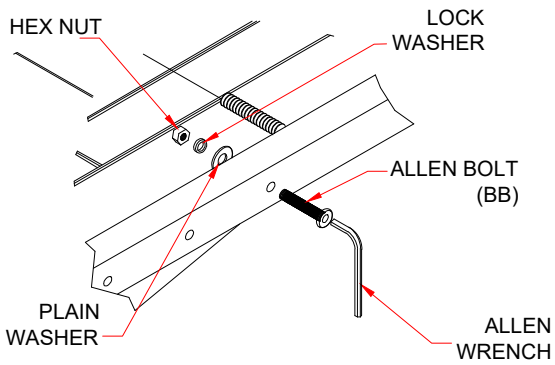

HARDWARE

(BB) 1/4" X 1-1/4" BOLT = 8 PCS

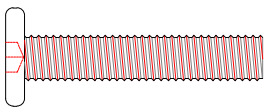

PLAIN WASHER = 8 PCS

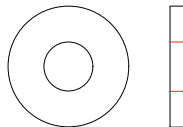

HEX NUT = 8 PCS

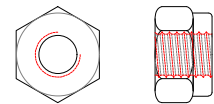

LOCK WASHER = 8 PCS



ALLEN WRENCH = 1 PC

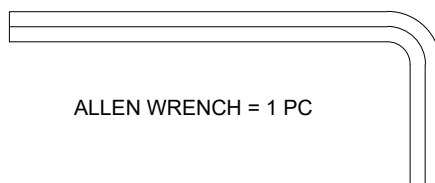

OPEN WRENCH = 1 PC

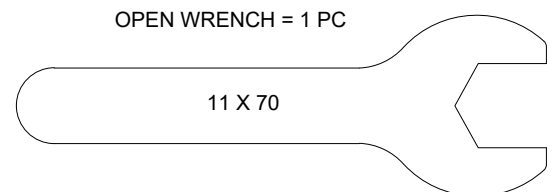

STEP #4

INSTALLATION OF STABILIZER RAILS INTO THE SIDE PANEL.

STEP #4.1

On inside face of both End Rail Panels are pre-installed metal brackets, designed to hold the stabilizer rails. Set both ends of the stabilizer rails into brackets, as illustrated in DETAIL F.

STEP #4.2

Once the stabilizer rails are set, gently tilt the toddler bed and fasten the stabilizer rails with bolt, lock washer and plain washer.

NOTE

After assembly, re-tighten all bolts to a snug fit.

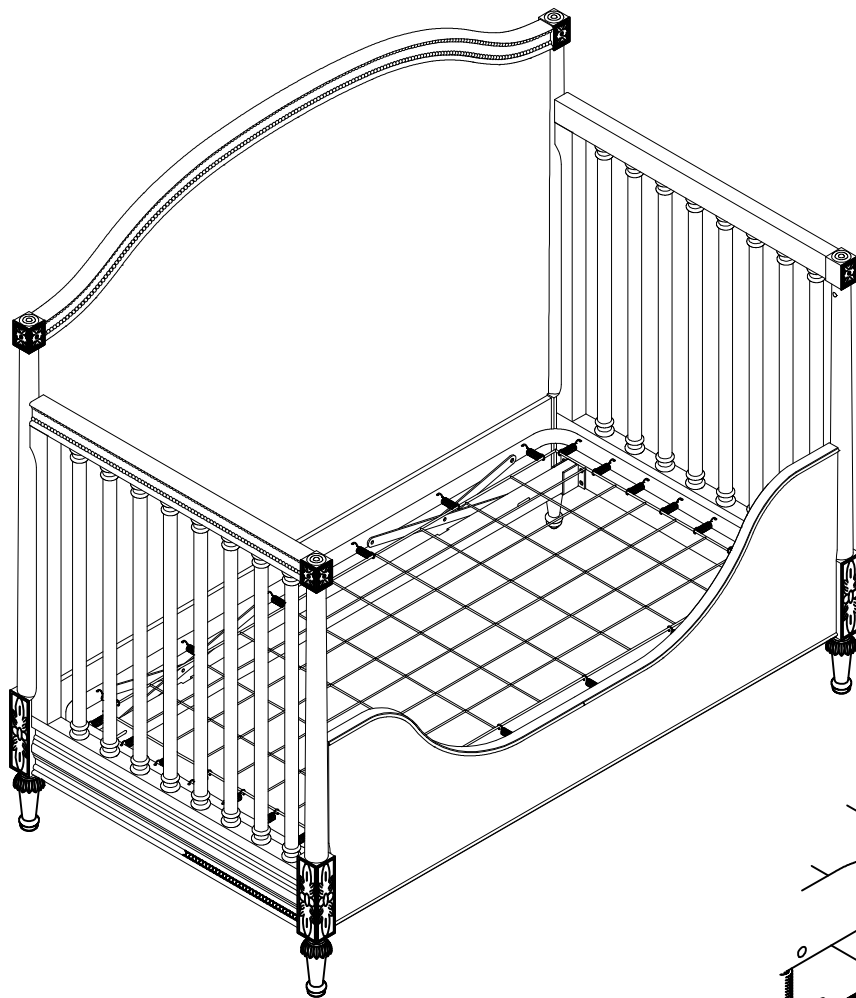

DETAIL F

